

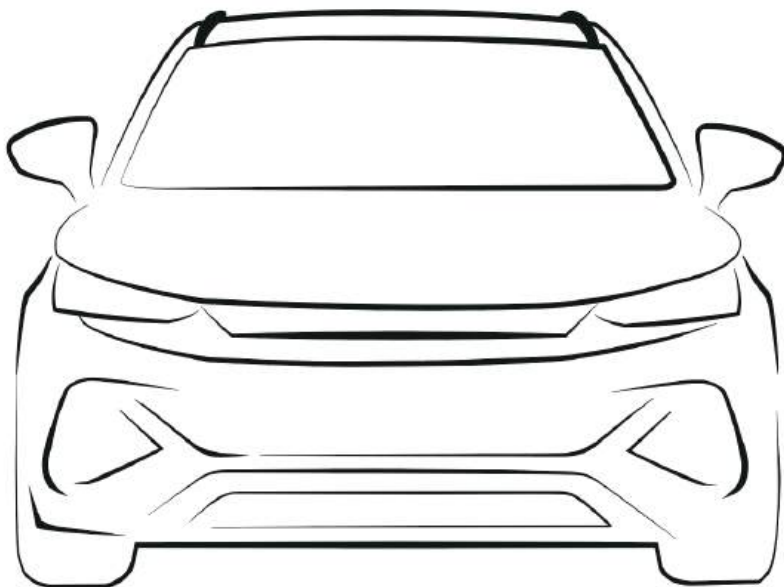

BYD ATTO 3

OWNER'S MANUAL



Foreword

Thank you for choosing BYD. To better use and maintain the vehicle, please read this manual carefully and keep it for future reference.

Special instructions: BYD Auto Co., Ltd. recommends that you choose genuine spare parts and use, maintain, and repair the vehicle in accordance with this manual. The use of non-genuine spare parts to replace or modify the vehicle will affect the performance of the entire vehicle, especially its safety and durability. Vehicle damage and performance issues caused thereby will not be covered by the warranty. In addition, vehicle modifications may also violate national laws and regulations and local government regulations.

Thank you again for choosing BYD. Your valuable comments and suggestions are welcome. To enjoy better services, please provide your accurate contact information. If there is any change to the information, contact a BYD authorized dealer or service provider in a timely manner to update the information in the system. You are also advised to pay attention to the relevant national laws and regulations and local policies, and register the vehicle as soon as possible; otherwise vehicle registration may fail.

The descriptions marked with the asterisk (*) in this manual are specific to only some model configurations, and applicable only when the vehicle has these configurations. If there is any difference with the vehicle you purchased, the configuration of the actual vehicle shall prevail.

Pay attention to the "REMINDER", "CAUTION" and "WARNING" symbols in this manual, and follow the instructions carefully to avoid injury or damage. These symbols are defined as follows:

REMINDER

Items that must be observed to facilitate maintenance.

CAUTION

Items that must be observed to avoid damage to the vehicle.

WARNING

Items that must be observed to ensure personal safety.



is a safety mark to indicate an operation that should not be performed or an event that should not happen.

This manual is expected to help you use the product correctly, and does not provide any description of the configuration and software version of this product. For details about the product configuration and software version, please refer to the contract (if any) related to this product, or consult the dealer who sold the product to you.

Sustainability

As a pure electric passenger vehicle, the BYD ATTO3 is an environmentally friendly product. Please visit <https://reach.bydeurope.com> for environmental protection information about the vehicle.

It is everyone's responsibility to protect the environment. Please use this vehicle properly and dispose of any waste and cleaning materials according to the corresponding local laws and regulations.

Contact Us

If you require assistance or clarification on policies or procedures, please contact the customer service center.

E-mail: Autoservice.contact@byd.com

Call 00800-10203000 for 24/7 roadside assistance or customer service (9:00-18:00, Monday-Saturday).

Copyright © BYD Auto Co., Ltd. All rights reserved.

No part of this document may be reproduced, copied, stored, translated, or transmitted electronically or in any other form without prior written consent and authorization of BYD Auto Co., Ltd.

All rights reserved

Figure Index

Exterior.....	7
Dashboard.....	8
Center Console.....	9
Doors.....	10

Safety

Seat Belts.....	12
Seat Belt Overview.....	12
Using Seat Belts.....	12
Airbags.....	15
Airbag Overview.....	15
Driver and Front Passenger Airbags.....	16
Front Seat Side Airbags.....	16
Side Curtain Airbags.....	17
Airbag Triggering Conditions and Precautions.....	18
Child Restraint Systems.....	23
Child Restraint Systems.....	23
Anti-theft Alarm System.....	29
Anti-theft Alarm System.....	29
Event Data Recorder System.....	29
Data Collection and Processing.....	29
Vehicle Data Processing.....	30
Permanent Vehicle Transfer to Third Parties and Offline Mode.....	32
Disclosure of Personal Data to Authorities.....	32
Your Data Protection Rights.....	32

Instrument Cluster

Instrument Cluster.....	36
Instrument Cluster View.....	36
Instrument Cluster Indicators.....	37

Controller Operation

Doors and Keys.....	48
Keys.....	48
Locking/Unlocking Doors.....	50
Smart Access and Start System.....	57
Child Protection Lock.....	58
Seats.....	59
Adjusting Front Seats.....	59
Seat Precautions.....	60
Folding Rear Seats.....	61
Head Supports.....	61
Steering Wheel.....	62
Adjusting the Steering Wheel.....	62
Switches.....	65
Light Switches.....	65
Wiper Switch.....	68
Driver's Door Switches.....	71
Odometer Switch.....	73
Driver Assistance Switches.....	73
Window Control Switch on Passenger Side.....	74
Hazard Warning Light Switch.....	74
Mode Switches.....	74
PAB Switch*.....	75
Emergency Call (E-Call).....	76
Sunroof Switch.....	77
Interior Light Switch.....	78

Using and Driving

Charging/Discharging.....	82
Charging Instructions.....	82
Charging.....	86
Discharging Device.....	91
Charging Port Immobilizer System.....	93

Range Mode*	94
Regenerative Braking Settings	94
Batteries	95
High-Voltage Battery	95
Low-Voltage Battery*	98
Usage Precautions	100
Break-in Period	100
Trailer Towing	100
Driving Safety Precautions	101
Vehicle Use Suggestions	101
Saving Energy and Extending Vehicle Service Life	102
Carrying Luggage	103
Wading into Water	104
Fire Prevention	105
Snow Chains	107
Starting and Driving	107
Starting the Vehicle	107
Driving	108
Gear Shift Controls	109
Electronic Parking Brake (EPB)	110
Automatic Vehicle Hold (AVH)	113
Driving Precautions	114
Driver Assistance	115
Adaptive Cruise Control (ACC)*	115
Intelligent Cruise Control (ICC)*	119
Predictive Emergency Braking (PEB)*	120
Traffic Sign Recognition (TSR)*	123
Lane Support System (LSS)*	124
Blind Spot Detection (BSD) System*	125
Tire Pressure Monitoring	128
Acoustic Vehicle Alerting System (AVAS)	130
Panoramic View*	130
Parking Assist System	132

Driving Safety Systems	135
0-100 km/h: Full Throttle Experience	139
Other Main Functions	140
Interior Rearview Mirror	140
Power Side Mirrors	140
Wipers	141

In-Vehicle Devices

Infotainment System	148
Infotainment System	148
BYD App	151
A/C System	154
A/C Panel	154
A/C Operation Interface	154
Function Definition	156
Vents	158
Air Purification System*	159
Switching on A/C with Cloud Service App	160
Storage Device	161
Door Bins	161
Glove Box	161
Center Console Cubby	161
Seatback Pockets	161
Cup Holder	161
Other Devices	162
Sun Visor	162
Grab Handles	162
USB Ports	163
12V Auxiliary Power	163
Wireless Phone Charger Location	163
Cargo Cover	165

Maintenance

Maintenance Information.....	168
Maintenance Cycle and Items.....	168
Smart Maintenance System*.....	170
Regular Maintenance.....	170
Regular Maintenance.....	170
Vehicle Corrosion Prevention.....	170
Paint Maintenance Tips.....	171
Vehicle Cleaning.....	172
Interior Cleaning.....	173
Self-Maintenance.....	174
Self-Maintenance.....	174
Sunroof Maintenance.....	176
Vehicle Storage.....	177
Hood.....	178
Cooling System.....	179
Braking System.....	179
Washer.....	180
A/C System.....	180
Wiper Blades.....	180
Tires.....	181
Fuses.....	184

When Faults Occur

When Faults Occur.....	186
If Smart Key Battery Is Exhausted.....	186
Emergency Shutdown System.....	186
Vehicle Fire Rescue.....	187
Battery Leakage Rescue.....	187
If the Vehicle Needs Towing.....	188
If a Tire Goes Flat.....	189

Specifications

Data.....	194
Vehicle Data.....	194
Vehicle Identification.....	197
Information.....	198
Warning Labels.....	198
Transponder Mounting Position.....	199
Declarations of Conformity.....	200
Declarations of Conformity.....	200
Manufacturer and Importer Information.....	203
Battery Parameters of Electrochemical Performance and Durability.....	205

Abbreviations

Abbreviations.....	211
---------------------------	------------

Figure Index

Exterior

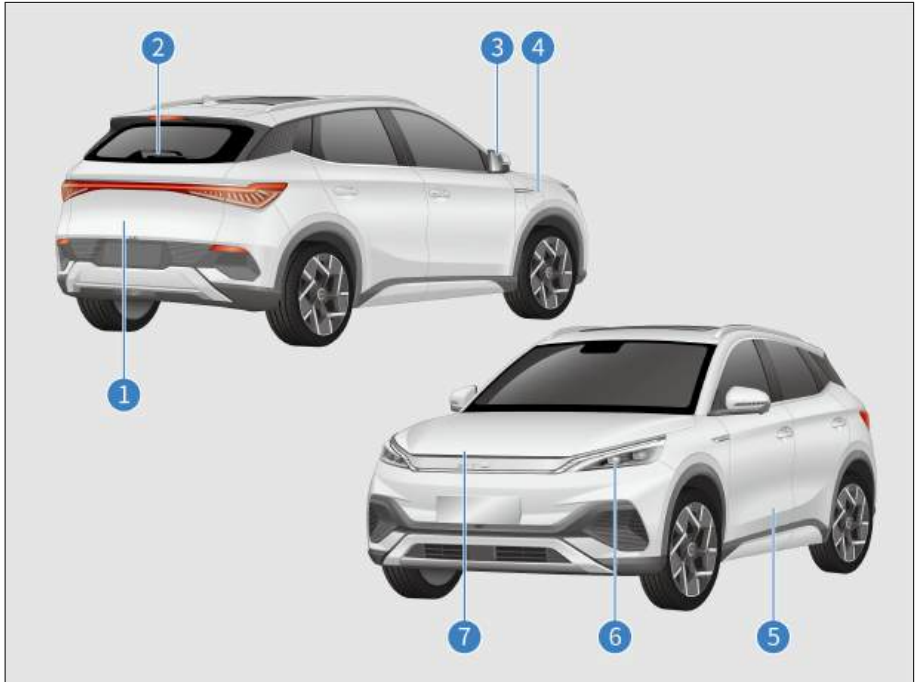

- 1 Locking/Unlocking the Trunk **P53**
Carrying Luggage **P103**
In-Vehicle Tools **P190**
- 2 Rear Wiper **P69**
- 3 Side Mirror Adjustment **P140**
- 4 Using Mode 2 Charging Cable **P86**
Using AC Charging Piles **P88**

- Using DC Chargers **P89**
External Discharging **P92**
- 5 Doors **P51**
- 6 Combination Lights **P65**
- 7 Opening the Hood **P178**
Coolant **P179**
Brake Fluid **P179**

Dashboard

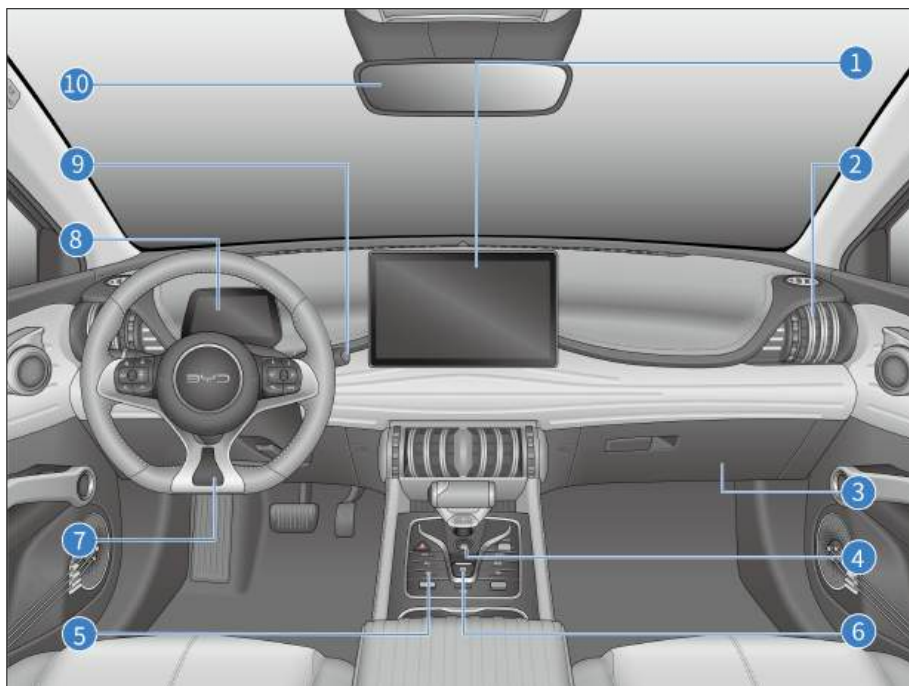

- | | | | |
|---|--|----|--|
| 1 | Infotainment Touchscreen P148
A/C Settings Interface P154
A/C Function Definitions P156 | 7 | Adjusting the Steering Wheel P65
Steering Wheel Switches P62 |
| 2 | A/C Vents P158 | 8 | Instrument Cluster P36 |
| 3 | Glove Box P161 | 9 | Front Windshield Wipers and Washer P68
Rear Windshield Wiper and Washer P69 |
| 4 | START/STOP Button P107 | 10 | Interior Rearview Mirror P140 |
| 5 | AVH Switch P113 | | |
| 6 | EPB Switch P110 | | |

Center Console

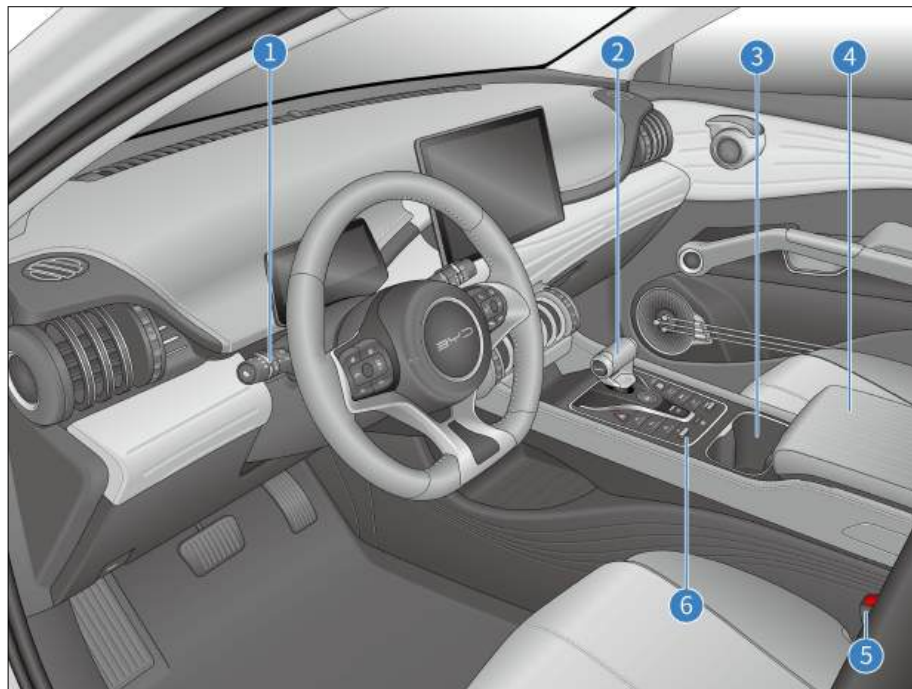

1 Light Adjustment Switch **P65**

2 Gear Shift Controls **P109**

3 Cup Holder **P161**

4 Center Console Cubby **P161**

5 Using Seat Belts **P12**

6 Mode Switches **P74**

Doors

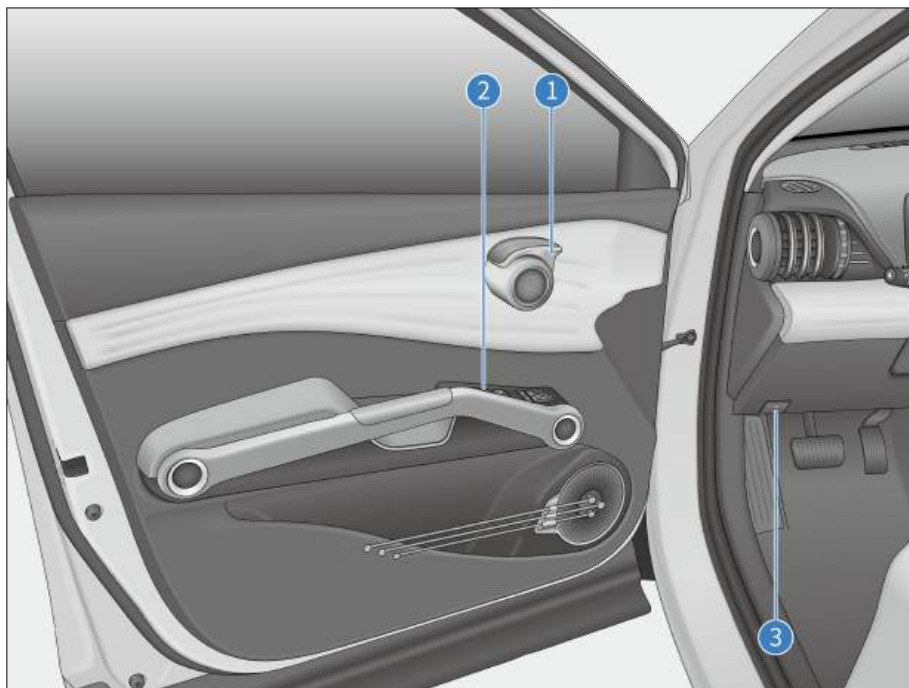

1 Opening with Interior Door Handle **P51**

2 Power Window Switches **P71**
Window Lock Button **P73**

Central Locking **P72**

Side Mirror Adjustment **P140**

3 Hood Handle **P178**

01

SAFETY

Seat Belts.....	12
Airbags.....	15
Child Restraint Systems.....	23
Anti-theft Alarm System.....	29
Event Data Recorder System.....	29

Seat Belts

Seat Belt Overview

Studies have shown that proper use of seat belts can significantly reduce casualties in emergency braking, sudden steering or collisions. Please read the following information carefully and observe it strictly.

WARNING

- Always have the seat belts fastened while the vehicle is in motion.
- Before driving, make sure all occupants are properly buckled up to prevent serious injury or death in emergency braking or in a collision.
- The seat belts are designed primarily to fit adults and are not intended for children. Make sure to choose a child restraint system appropriate for your child's age and size (see **P23**).
- If a seat belt is damaged or malfunctions, immediately contact a BYD authorized dealer or service provider for confirmation and handling. Until then, do not use the corresponding seat.

- BYD has highly emphasized that all occupants should always fasten their seat belts while in the vehicle. Failure to do so increases the risk of injury in case of an accident.
- Children are encouraged to travel on the rear seats and must be buckled up in appropriate child restraint systems.
- Do not allow children to travel standing or kneeling on the rear seat,

nor sitting on someone's lap, for there is a high risk of serious injury in case of emergency braking or collision.

Emergency Locking Retractor Function

- When the driver turns sharply or brakes suddenly, when there is a collision, or when the occupant leans forward too quickly, the seat belt automatically locks to effectively restrain and protect the occupant.
- When the vehicle travels smoothly, seat belts are pulled out and retracted as the occupants move slowly and smoothly, allowing the occupants to move freely.
- If the seat belt locks due to sudden retraction, pull on the seat belt webbing to create retractable slack in order to pull out the seat belt.

Pretensioner and Force Limiter Function*

When a severe front collision occurs and the triggering conditions of the pretensioner are met, the pretensioner quickly retracts part of the seat belt and locks it to improve the protection of the occupant. The force limiter limits the seat-belt restraint force to the occupant's body to a certain extent so as to avoid injury to the occupant due to an excessive restraint force.

Using Seat Belts

1. Adjust the seat position and seatback angle (see **P59**).
2. Adjust the position of the three-point seat belt.
 - Keeping a proper sitting posture, pull the seat belt out so that it is diagonally across the chest. The belt should not

go under the arm or across the back of the neck.

- Keep the lap section of the belt as close as possible to the hips.

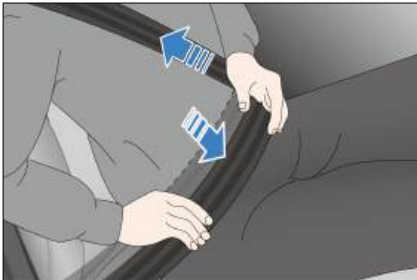

3. Insert the latch into the buckle until it clicks, and then pull it back to make sure it is firmly locked. Do not fasten the belt with any part of the strap twisted.



4. Adjust the height of the (front) seat belts for optimum comfort and protection.

① Press the adjuster release button.

② Move the adjuster up or down to the intended position. Release the button to lock the adjuster.

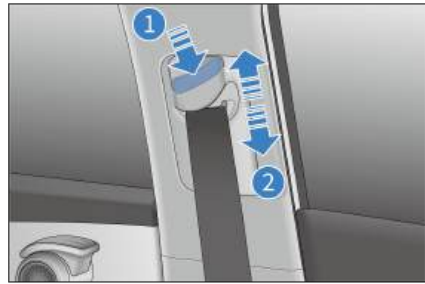

5. Pull the belt firmly to check that the adjuster is locked.

WARNING

- The shoulder belt should cross the center of the shoulder. The seat belt should be far from the neck and not liable to slip from the shoulder; otherwise, it cannot function well in the event of emergency braking or accident and may even cause severe injury.
- The lap belt should be positioned as low as possible around the hips to avoid serious injury due to the intense lap belt forces against the abdomen in an accident.
- The seat belt should be fitted tight to the body for better protection.

6. Unlock the seat belt.

- Press the red unlock button on the buckle. The latch plate pops out, and the seat belt automatically retracts.
- If the seat belt does not retract smoothly and automatically, pull it out and check whether it is twisted.



WARNING

- One seat belt is for one occupant only. Do not allow multiple occupants (including children) to share one seat belt.
- Avoid traveling with the seatback leaning too far back. The seat belt protection performs best when the seatback is upright.
- Make sure that no seat belt or its spring bolt/buckle becomes pressed by the door or rear seatback; otherwise, the seat belt may be damaged.
- Check the seat belts regularly for cuts, wear, looseness, and other abnormalities. If any problem is found, contact a BYD authorized dealer or service provider for confirmation and handling. Until then, do not use the corresponding seat.
- Do not remove, disassemble or modify the seat belts without permission.
- After an accident, have the seat belts checked at a BYD authorized dealer or service provider. If the pretensioner function is activated, the seat belt must be replaced. Use an approved model whenever you replace the seat belt.
- In the event of a serious accident, even if there is no

WARNING

apparent damage, the seat belt should be replaced along with the seat assembly. The airbag system should also be thoroughly inspected.

- Pregnant women need to fasten the seat belts properly and position the lap belt as low as possible around the hips to avoid serious injury from the intense lap belt forces against the abdomen in an accident.
- The method of wearing a rear seat belt is the same as that for a front seat belt. For normal functioning of the rear seat belt, please ensure that its latch is inserted into the corresponding buckle during use. The driver should ensure that all occupants are wearing seat belts before driving the vehicle.
- Do not insert foreign objects such as coins and clips into the buckle as they prevent proper connection between the latch and buckle.

Seat Belt Reminders

If any occupant has not buckled up after the vehicle is started, visual and audible alarms go off and continue until the corresponding seat belt is properly fastened.

- Seat belt reminder indicator
This indicator flashes if any seat belt is not fastened.
- Display of unfastened belt's seat
The indicator for the seat with unfastened seat belt lights up.
- Unfastened seat belt reminder*

If any vehicle occupant has not buckled up after the ignition is switched on, the seat belt reminder indicator and the indicator associated with the corresponding seat* light up. If the seat belt remains unfastened while driving, in addition to the reminder indicator, an audible alarm is given to alert the driver and the occupants.

- When the driver and the passengers fastened their seat belts, the seat belt reminder indicator turns off and all indicators displayed for the corresponding seats* turn off.

WARNING

- In the event of abnormality or function failure, contact a BYD authorized dealer or service provider. Do not use the corresponding seat until the functions return to normal.
- When driving, make sure all occupants have their seat belts properly fastened to prevent personal injury or even death in emergency braking or in a collision.

Airbags

Airbag Overview

- The airbag system is a part of auxiliary restraint system and also a supplement to seats and seat belts. When the vehicle is involved in a serious collision and the airbag system meets its deployment conditions, relevant airbags will rapidly deploy and, along with seat belts, provide additional protection for heads and chests of the driver and occupants, to

reduce likelihood of personal injury or even death.

- Airbags are divided into front and side types according to the type of collision. The front airbags include a driver airbag and a front passenger airbag, while the side airbags include front seat side airbags and side curtain airbags.
- As an integral part of the vehicle's passive safety protection system, the airbag system does not replace seat belts, and must be used in combination with fastened seat belts to maximize protection.

Multi-Collision Brake(MCB)

- In the event of an accident, the automatic braking will be activated when the driver airbag or the front passenger airbag deploys.
- Speed reduction, along with intervention by additional driving systems (ESC and ABS), assists the vehicle to maintain stability and lane position.
- Hazard warning light and brake light would light up to warn oncoming vehicles and aid to avoid secondary collision.
- The brake is released after an accident and brake lights are turned off to support emergency rescue or recovery of the affected vehicle.
- The driver can interrupt the multi-collision braking at any time by accelerating or braking.

CAUTION

- Occupants must sit in a proper position to maximize the protection provided by seat belts and the airbag system.

CAUTION

- Do not disassemble or assemble airbag components.
- Non-BYD genuine seat covers may worsen the airbag performance or result in injury. Do not place anything between the side airbag and the occupant.
- Do not apply excessive force to the side of seats equipped with side airbags.
- After a crash, even if the airbag did not deploy and the pretensioner did not lock the seat belt, contact a BYD authorized dealer or service provider for inspection as soon as possible to ensure that the airbag system functions correctly.

Driver and Front Passenger Airbags

- This vehicle is equipped with driver and front passenger airbags, when the airbag system Electronic Control Unit(ECU) detects a moderate to severe front impact during driving and the triggering conditions are met, the airbags deploy to minimize the injury.



Front airbag deployment

- In moderate to severe frontal crashes, a sensor detects a sharp deceleration

and sends a signal to the ECU to trigger the front airbags.

- When there is a frontal crash, the seat belt secures the occupant's lower body and torso in place. The airbag cushions and protects the occupant's head and chest.
- When the severity of the impact does not reach the airbag deployment threshold, seat belts provide enough protection.
- The front airbag deflates immediately after inflation, without affecting the driver's vision and ability to operate the steering wheel or other controls.
- The airbag deploys within a thousandth of a second to further protect drivers and occupants in an accident.
- A loud noise will be heard when the airbag deploys. It will not cause injury, but it may cause tinnitus or temporary deafness which recover quickly.
- A cloud of dust from the airbag surface may come off when the airbag deploys. Although such powder is non-toxic, individuals with respiratory problem might experience some temporary discomfort.
- The front passenger airbag is controlled by the passenger airbag (PAB) switch. For details, see **P75**.

Front Seat Side Airbags

- The vehicle is equipped with side airbags for the left and right front seats (installed in the outer edges of the front-row seatbacks and marked with "AIRBAG", as shown in the illustration):

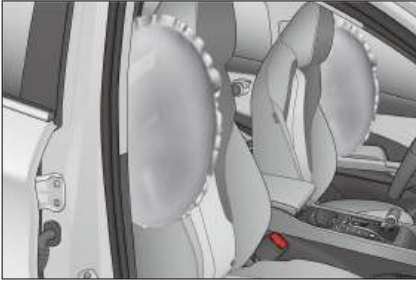

- When a moderate to severe side impact is detected during vehicle travel, and the triggering conditions are met, the side airbag deploys to protect the chest of the occupant on the side of collision.
- Generally, only the airbag on the impacted side deploys in the event of a side impact.
- If the impact occurs on the passenger side, the airbag on the passenger side deploys even if there is no passenger in the seat.
- For optimal side airbag protection, occupants must have their seat belts fastened and sit upright against the seatback.

Front far side airbag:

- The vehicle is equipped with a far side airbag (installed in the inner edge of the driver's seat and marked with "AIRBAG", as shown in the illustration).



- When a moderate to severe front or side impact is detected during vehicle

travel and the triggering conditions are met, the far side airbag deploys to protect the heads and shoulders of the driver and the front passenger.

- If the impact occurs on the front passenger side, the far side airbag deploys even if there is no passenger in the seat.
- For optimum protection from the driver far side airbag, the occupant must have the seat belt fastened and sit in an upright position.

In a vehicle equipped with seat side airbags:

- Prevent the seatbacks from getting wet. If they get wet from rain or splashes, the side airbag system may not work properly.
- Do not cover or replace seatback covers on your own. Unsuitable seatback cover replacements or covers may prevent airbag deployment in a collision.

Side Curtain Airbags

- The vehicle is equipped with curtain airbags for the left and right seats (installed at the junction of the body side trim and the ceiling and marked with "AIRBAG" on the A-pillar, B-pillar, and C-pillar trims, as shown in the illustration).
- When a moderate to severe side impact is detected by ECU and the triggering conditions are met, the side curtain airbag deploys to protect the head of the occupant on the side of collision.



- Generally, only the airbag on the impacted side deploys in the event of a side impact.
- For optimum curtain airbag protection, the occupant must have their seat belt fastened and sit upright against the seatback.

Airbag Triggering Conditions and Precautions

- Airbag triggering conditions: In the event of a vehicle collision, whether an airbag will be triggered is decided by factors such as the amount of collision energy, accident type, collision angle, obstacles and vehicle speed. The airbag system may be triggered in special collisions.
- The airbag system does not always work in any accident, and generally it will not be triggered in the event of a minor frontal collision, rear collision or rollover. In this case, the driver and passengers are protected by their properly fastened seat belts.
- Determinants of airbag system triggering: Decision is made by comparing the deceleration curve, generated in the collision and obtained by the electronic control unit (ECU) and the set value. If signals, such as the deceleration curve generated and measured in the collision, are lower

than the respective reference values preset in the ECU, the airbag system will not be triggered even if the vehicle may have been seriously deformed in the accident.

- The ECU of the BYD airbag system has been set up with considerations of common misuse and road conditions. However, due to the increasing changes in causes and forms of vehicle collisions, for your safety, please strictly follow this user manual, use the vehicle correctly, and avoid its misuse. Otherwise, there is no guarantee that the airbags will achieve their expected effect.

Cases When Airbags May Be Deployed

When crossing the deep groove, the front of the car hits the ground.



Hit a bump, kerb, etc on the side of the road.



When going down a steep slope, the front of the car hit the ground.

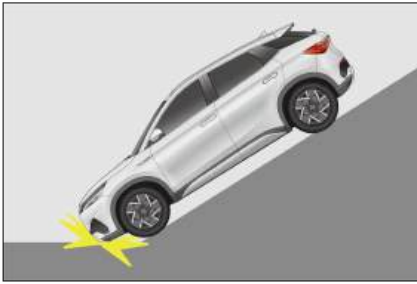

One side of the vehicle is hit by another vehicle.

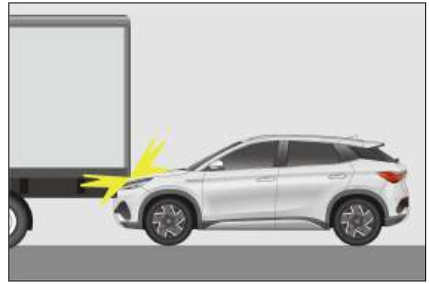

The tail of the vehicle is hit by another vehicle.

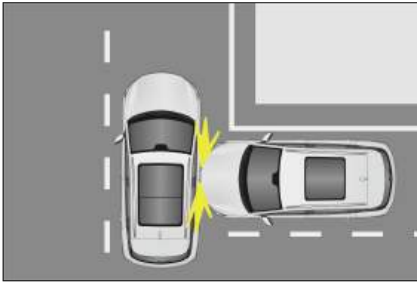

Cases When Airbags May Not Be Deployed

The vehicle hits a concrete column, tree, or other slim objects.



The vehicle goes under a truck or another large vehicle.



The vehicle rolls over.

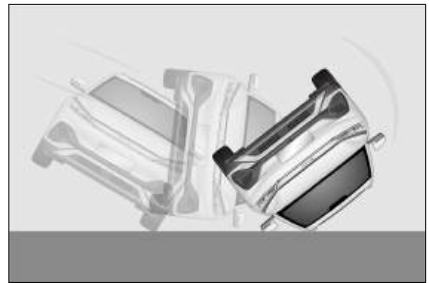

The vehicle hits a wall or a vehicle at a side other than the front side.



Parts other than the passenger compartment receive side impact.

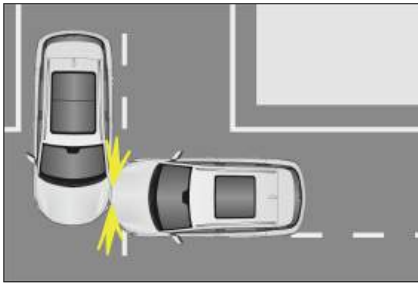

The lateral side of the vehicle is hit diagonally.

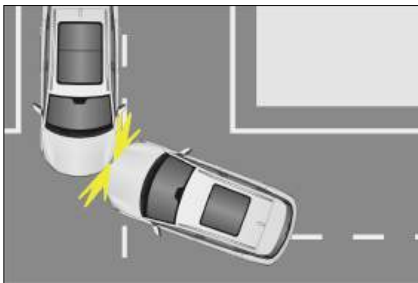

The lateral side of the vehicle hits a columnar object.



! WARNING

- Airbags are designed for specific models. Any changes to suspension, tire size, bumpers, chassis and factory-equipped devices may adversely affect the airbag system. Users must not use any parts of the airbag system on other car models; doing so may lead to failure of the airbag system.
- Drivers should maintain a distance of at least 25 cm between their chest and the steering wheel, in order for the system to provide the most effective driver protection.
- Fasten your seat belt and sit properly while the vehicle is in motion. If the seat belt is not fastened, if the occupant is leaning forward or sitting improperly, airbag deployment can increase the risk of injury.
- Do not paste stickers, cover or decorate the hub cover of the steering wheel, the right side surface of the dashboard or the surface of A, B, and C pillar trims. Clean these surfaces with a dry or damp cloth, without applying too much pressure.
- A child is not to be seated in the front passenger seat, nor

 **WARNING**

are they to ride sitting on a front passenger's lap, to prevent serious injury or even casualty caused by airbag deployment.

- Side airbags and side curtain airbags deploy quickly with high impact forces. Occupants must not lean against the doors of vehicles equipped with these airbags while these vehicles are in motion. Failure to do so could result in serious injury or even death.
- Do not modify or replace seats or trims of the seats with side airbags. These changes may prevent normal deployment of side airbags, and thereby cause airbag system failure or unintended deployment of side airbags, resulting in serious injury or death.
- Do not place any other accessories or items within the action range of side curtain airbags, including the windshield, side door glass, A-pillar trim, ceiling, B-pillar trim, C-pillar trim and auxiliary handles. When the side curtain airbag deploys, the accessories or items will be thrown by the impact force from the side air curtain airbag, or the side curtain airbag may not deploy normally, resulting in serious injury or even death.
- When transferring car ownership, make sure to pass on all of the vehicle's documents and keep the new ownership informed of airbag conditions and replacement dates.
- Do not disassemble or repair the A-pillar trim, ceiling, B-pillar trim

 **WARNING**

or C-pillar trim, which contain side curtain airbags. These changes can cause failure of the airbag system or accidental deployment of curtain airbags, which may cause serious injury or even death.

- Do not change any component of the airbag system, including any corresponding label. It is recommended that any operation done to the airbags be performed by a BYD authorized dealer or service provider.
- Airbags can only provide one-time accident protection. Once the airbag is triggered or damaged, the airbag system must be replaced.
- Follow safety regulations and procedures related to the scrapping of parts of the vehicle or its airbag system.
- The airbag system has strong anti-interference and anti-disturbance resistance to electromagnetic fields around it. However, to avoid accidents, do not use the vehicle in an electromagnetic environment that violates national regulations.
- The airbag system of this vehicle is designed with full consideration of common misuses and road conditions. However, in order to avoid accidents, do not have the bottom of the vehicle impacted or drive roughly in harsh road conditions.
- This vehicle's airbag system has been fully verified to seamlessly match the vehicle's original wiring harness system. Any wiring

⚠ WARNING

harness modification or alteration may cause the airbags to deploy mistakenly under normal conditions or fail to deploy in the event of a collision.

It is recommended that you contact a BYD authorized dealer or service provider immediately if any of the following situations occurs.

- The airbag has deployed.
- Instrument cluster airbag warning light  lights up abnormally.
- This airbag system is monitored by the ECU and has a self-diagnosis function. Its status is displayed by the airbag warning lights on the instrument cluster.
- With the ignition on, if the airbag warning light stays on for about five seconds and then disappears for more than five seconds, the system is running smoothly.

If any of the following events occurs, the airbag system is faulty. Please contact a BYD authorized dealer or service provider immediately.

- When the ignition is switched on but the warning light goes off.
- When the ignition is switched on but the warning light does not go off after five seconds, or goes off and then on again.
- When the ignition is switched off but the warning light turns on.
- This warning light turns on or flashes during driving.
- There is a collision with the front of the vehicle (highlighted area shown), but the front airbags do not deploy.

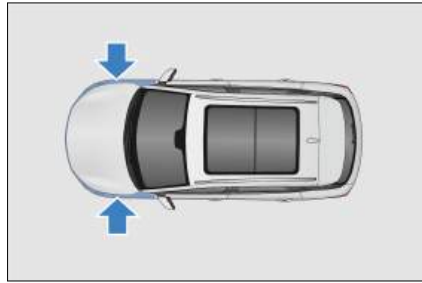

- The airbag cover has been scratched, cracked or otherwise damaged.

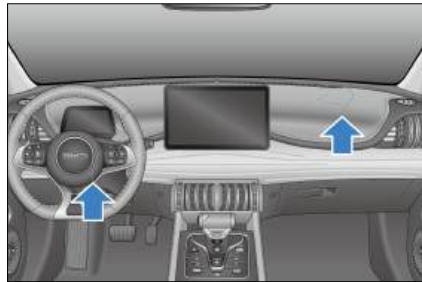

- Airbags need to be removed, disassembled, installed or repaired.
- Side airbags and curtain airbags have deployed.
- An impact to a vehicle door in an accident is not adequate to cause the airbag to deploy.
- The surface of the seat with a side airbag is scratched, cracked, or damaged similarly.
- Decorative (liner) parts at A-pillar with built-in curtain airbags, roof beam and C-pillar are scratched, cracked, or damaged similarly.

Child Restraint Systems

For the child's safety, please carefully read the instructions provided with the child restraint and in this manual before installing a child restraint.

Child Restraint Systems

- Child restraint systems provide good protection to your child in an accident.

- Choose a suitable child restraint system for your child's age and stature.

Recommended child restraint systems:

Weight Group	Child Weight	Child Restraint System	Type
Group 0	less than 10 kg	-	-
Group 0+	less than 13 kg	Maxi Cosi Cabriofix	Universal class
Group I	9-18 kg	Britax Römer King II LS	Universal class
Group II	15-25 kg	Britax Römer KidFix ² S	Universal class Semi-universal class
Group III	22-36 kg	Britax Römer KidFix ² S	Universal class Semi-universal class

- ① Group 0+
- ② Group I
- ③ Group II / Group III



- Children must use a suitable child restraint when traveling in the vehicle. Children should sit comfortably and safely. Make sure that the child restraint is positioned, mounted, and used correctly.

- If the child is too large to use a high-back child restraint, please sit in the rear outboard seat and follow the installation instructions provided by child restraint manufacturer to use the booster chair attached to the lower anchoring device, or use the seat belt.

WARNING

- Never carry a child on your lap in a vehicle journey.
- An appropriate child restraint system must be used for your child.
- Please follow the instructions provided with the child restraint system and in this manual to make sure the child restraint is properly installed in the vehicle.

⚠ WARNING

- After the child restraint is dismounted from the seat, store it safely in your trunk.
- Failure to follow the instruction provided with the child restraint and in this manual may cause injuries and even death to your child in an accident.

- Secure the top tether when installing the child restraint system.

Installing Child Restraint Systems

Rear outboard seat

- The rear outboard seats are equipped with ISOFIX/i-Size anchorages.
- The anchorage locations are identified by a marking (see illustration) located on the seatback, directly above the associated anchorages.



- The rear seats are equipped with tether strap anchorages on the back of the seat.

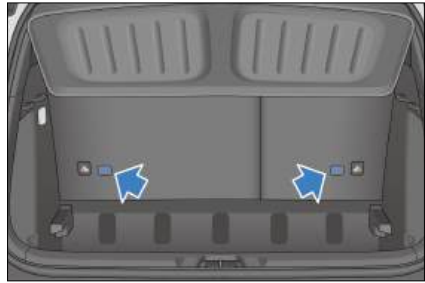

Installing a child restraint

1. Check the position of the special anchorage and install the child restraint on the seat.



⚠ CAUTION

- The anchorages are located in the gap between the seat cushion and the seatback.
- When any child restraint system is installed, except for a booster seat without a back, it is advised that the adjustable head support is removed, and stowed safely.
- When a booster seat without a back is installed, adjust the head support to a proper position.
- When the seat position does not have any child restraint system or booster seat installed, install the head support and adjust it to a proper position.

2. Attach the tether strap to the anchorage, then tighten the top tether

as per the instructions provided by the manufacturer of the child seat. Make sure that the tether strap is attached securely.

- ① Top tether
- ② Anchorage

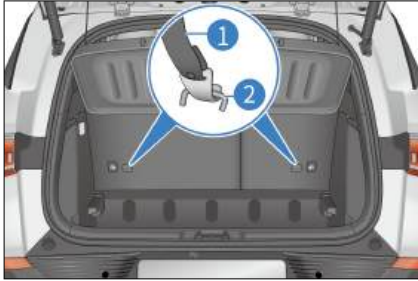

⚠ CAUTION

- Before installing the child restraint top tether, remove the cargo cover.
- After the seat head support is removed, keep it in the trunk.
- BYD recommends installing the child restraint system using the International Standards Organization Fix (ISOFIX) anchorages of the vehicle.
- If the driver seat obstructs or interferes with the correct installation of the child restraint system, install the child restraint system on the other rear outboard seat.

Child restraint installed on front passenger seat*

- The switch is located on the front passenger side of the dashboard and is accessible when the passenger's door is open.
- When using a rear-facing child restraint, switch off the front passenger seat airbag by the PAB switch.

- See **P75** for details.



- Check the position of the special anchorage and install the child restraint on the seat.

⚠ WARNING

- Never use a rear-facing child seat on the front passenger seat if the airbag is activated.
- ISOFix/i-Size anchorage points are available for the front passenger seat and the label indicating an anchorage point location is attached to the seatback above the relevant anchorage.

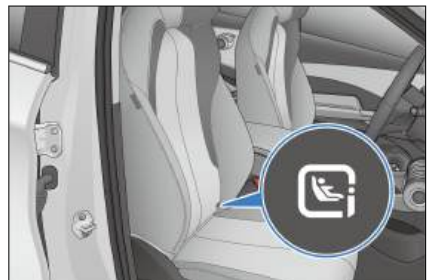

- An anchorage is provided for child restraint installation at the back of the front passenger seat.

Always follow the instructions below when using a child restraint on the front passenger seat:

- Never use a rear-facing child restraint on the front passenger seat if the

passenger airbag is activated. The airbag must be activated immediately after the rear-facing child restraint system is dismantled from the front passenger seat.

- If needed, adjust the front passenger seat backwards so that there is no contact between the child and vehicle interior.
- If needed, the front passenger seatback can be adjusted so that it has secure contact with the child restraint system.
- For child restraint systems with the guide fitting of belt attached to the child seat headrest, ensure that the guide fitting is positioned forward or in line with the seat belt upper anchorage on the vehicle's B-pillar.
- When a forward-facing child restraint system is used on the front passenger seat, ensure that the seat is positioned fully rearward away from the active airbag.
- Ensure that the seat belt passes through the guide fitting without kinking and is not bent over the edge of the guide fitting.

WARNING

- When the front passenger airbag is disabled, it is not allowed to seat in the front seat(including adults and children).
- Please make sure when the children restraint system is applied: anchorage is not limited, seat belts are in the right position, children restraint system is installed firmly.

CAUTION

- Extension straps may be required to connect the top tether to the anchorage, if the top tether length is insufficient.
- When installing a size class R3 child restraint system, ensure the seat is fully rearward before the installation.
- Where applicable to use a top tether strap with the child restraint system, ensure the strap is routed through the hole in the head support before attaching and tensioning the strap to the anchorage point at the base of the seat.



- For details about installing the child restraint system on the front passenger seat, see the preceding description.

Securing a child restraint with the seat belt*

- Only use child seats that are recommended by BYD, are universally approved, or are semi-universal and where the vehicle model is included on the child restraint manufacturer's vehicle list.
- Installation options are shown in the table below.

Group	Child Weight	Front Passenger Seat*		Rear Seats
		Front passenger front airbag ON	Front passenger front airbag OFF	
Group 0	less than 10 kg	X	U	U
Group 0+	less than 13 kg	X	U	U
Group 1	Rear-facing	X	U	U
	Front-facing	U	X	U
Group 2	15 to 25 kg	U	X	U
Group 3	22 to 36 kg	U	X	U

Note: Table definitions:

U: universal

X: seat position not suitable for installing a child restraint for this weight group

Quick guide to ISOFIX and i-Size installation

- The identification mark of ISOFIX or i-Size anchorage points is specified by the corresponding country/region.

- The following table shows the installation options for ISOFIX or i-Size child seats at the ISOFIX or i-Size anchorage points of the individual vehicle locations.

Group	Child restraint orientation	Size class / ISOFIX class	Front Passenger Seat*		Rear Outboard Seat	Rear Middle Seat
			Front passenger front airbag ON	Front passenger front airbag OFF		
Group 0: Up to 10 kg	Rear-facing	E/R1	X	IL-SU	IL-SU	X
Group 0+: less than 13 kg	Rear-facing	E/R1	X	IL-SU	IL-SU	X
		D/R2 C/R3				
Group 1: 9 to 18 kg	Rear-facing	D/R2	X	IL-SU	IL-SU	X
		C/R3				

Group	Child restraint orientation	Size class / ISOFIX class	Front Passenger Seat*		Rear Outboard Seat	Rear Middle Seat
			Front passenger front airbag ON	Front passenger front airbag OFF		
		B/F2X				
	Front-facing	B1/F2X	IL-SU, IUF	X	IL-SU, IUF	X
		A/F3				
Group 2: 15 to 25 kg	Front-facing	-	IL-SU	X	IL-SU	X
Group 3: 22 to 36 kg	Front-facing	-	IL-SU	X	IL-SU	X
i-Size child restraint system	Rear-facing	-/R2	X	i-U	i-U	X
	Front-facing	-/B2, F2X	i-U	X	i-U	X
Booster seat	Front-facing	-/B2, B3	i-B	X	i-B	X

Size class:

- The size class shown corresponds to the applicable weight range of the child restraint.
- The size class of the child restraint applicable to the universal group or semi-universal group is indicated on the ECE approval label.
- The child restraint is attached with a size description.

X:

- The seat is not suitable for installing an ISOFIX or i-Size child restraint in this group.

IL-SU:

- The seat is suitable for installing a semi-universal ISOFIX child restraint.

- Please note the list of applicable models provided by the child restraint manufacturer.

IUF:

- The seat is suitable for installing a universal ISOFIX child restraint.

i-U:

- The seat is suitable for installing a universal front-facing or rear-facing i-Size child restraint.

i-UF:

- The seat is suitable for installing a universal front-facing i-Size child restraint.

i-B:

- The seat is suitable for installing a front-facing ISOFIX booster cushion of Groups 2/3 and a front-facing i-Size child restraint for children with a

height of 100 – 150 cm (approximately 39 – 59 inches).

Anti-theft Alarm System

Anti-theft Alarm System

Anti-theft alarm system

- When armed, the system sounds an alarm* and turn signals flash when any door, the trunk, or the hood is forcibly opened.



Arming the system

1. Switch the ignition off.
2. All occupants get off the vehicle.
3. Lock all doors.

Triggering the alarm

- The system will raise an alarm in any of the following situations:
 - Any door, trunk, or hood is opened without using the keyless access function of the smart key.
 - The vehicle is powered on without using the smart key start function.

Disarming the system

- Anti-theft alarm can be stopped by:

- Unlocking the door with a valid smart key.
- Use of an NFC to unlock the vehicle.
- Use of the microswitch to unlock the vehicle.
- Use of a valid smart key to remotely unlock the trunk.
- Starting the vehicle remotely with a valid smart key.
- Pressing the START/STOP button inside the vehicle while carrying a valid smart key.

WARNING

- Do not modify the anti-theft alarm system by means of alteration or addition. Otherwise, the system may fail.

Anti-theft Indicator*

When the alarm is armed, the anti-theft indicator is solid on for about 10 seconds.



Event Data Recorder System

- This section provides you with some important information on how personal data is collected and processed when you use a BYD vehicle.

- For a more detailed overview on data processing, data protection and data subject rights, please read the current version of the privacy policy for the vehicle available at the infotainment system (**System** → **More** → **BYD Vehicle System Privacy Statement**).
- This vehicle is equipped with an Event Data Recorder(EDR) system. EDR mainly records data in the event of a crash or near-crash (for example, airbag deployment or hitting on a roadside obstacle) to help comprehend the vehicle system operation, such as:
 - Vehicle velocity
 - Tire pressure condition
 - Adaptive cruise control (ACC) system status
 - Whether the seat belt is fastened
- The vehicle records EDR data only when there is a crash or when a near-crash event reaches a certain extent. The EDR does not record any data during the normal driving of the vehicle.
 - The data recorded by the EDR system provides an understanding of the state of the vehicle's safety-related systems when an accident occurs, so that relevant parties can analyze the accident.
 - The EDR data needs to be accessed and read by special equipment. BYD discloses your personal data to third parties only if this is legally permissible or you have consented to it. In addition to the vehicle manufacturer, third-party agencies with professional equipment (such as government agencies) can also read the EDR data if they have access to the vehicle EDR and equipment (for example, they can read the data

of SRS control unit to clarify the accident).

Vehicle Data Processing

- Data is collected when the vehicle is used, such as data collected or transmitted by vehicle sensors or control units, which is necessary for the safe functioning of your vehicle.
- In some cases, the data is used to support driving (driver assistance systems) or to enable a specific comfort or infotainment function.
- Personal data that is collected and processed mainly include in-vehicle data, remote-services-related data, and other data, as further specified below.

In-vehicle data

Operation data

- When the vehicle is used, various vehicle status data (e.g., speed, battery level, and braking system) or environment (e.g., distance sensors and temperature) data are collected and processed.
- This data is not usually stored, but there are control units, sensors or other components installed in the vehicle that record such data, for example, to record maintenance requirements, error messages, or other information.
- The in-vehicle data will only be stored in the equipment in the vehicle but can be read out via the legally required OBD ("On Board Diagnostics") interface, for example, by BYD authorized dealer or service provider or other third parties.
- In case this access takes place during vehicle maintenance, the information can also be transmitted to

BYD engineers for quality assurance, product defect reports, or customer claim verification.

Remote-services-related data

Remote monitoring services

- The vehicle has remote monitoring services. These include remote diagnosis and over-the-air (OTA) updates and upgrades for security and safety purposes (subject to owner's approval).
- These monitoring services serve the following purposes: service provision (remote support/diagnostics), product development, and security/public safety.
- Depending on the country and setup, various vehicle information can be transmitted to BYD's data center in corresponding market for the above purposes, including vehicle location information, vehicle status, such as energy consumption, vehicle speed, gear position, power mode, ESC status, steering system status, battery status, powertrain status, and overall vehicle performance status.

Other

Infotainment system

- Depending on vehicle configuration, data can be added to the infotainment system by the users themselves, such as media data for playing video on the infotainment system, address data for use in the navigation system, or data for use in online services.
- Depending on vehicle configuration, individual settings in and on the vehicle can also be entered.
- Data stored in the vehicle can be deleted at any time.
- BYD has no control over data transferred to third parties (from the

use of third party content, in particular as part of online services).

Integration of mobile devices

- Depending on vehicle configurations, mobile devices can be connected and controlled through the vehicle's infotainment system.
- It may be necessary that the device's screen or audio is displayed/played through the infotainment system or transmitted to it.
- Additional data like positioning or vehicle information can be transmitted through applications for use in certain navigation systems, communication, or other third-party services.
- The specific type of data processing depends on the respective function and is controlled by the user or third parties such as the provider of the devices or corresponding services.

Internet access and connected services

- Depending on vehicle configurations, the Internet can be accessed for certain functions or BYD services through the vehicle's infotainment system network devices.
- BYD is not liable for any such services provided by any other party.
- In such cases, please obtain information about the use of data from the provider of the respective online service.



Camera image recording/surrounding area monitoring

- Your vehicle is equipped with a number of cameras/sensors.
- The reason for this is that some vehicle functionalities require the vehicle's path to be detected and assessed which is done by cameras that detect objects in the vehicle's surroundings (e.g., obstacles).

- The images are transmitted to the respective control module for further analytics required to operate the systems.
- Some images are just processed on a volatile basis (RAM), others may be stored, depending on vehicle equipment.
- The vehicle may be equipped with an outward-facing camera (OFC) that can be used to take footage of the surrounding (for example, dashcam).
- The vehicle may also be equipped with an inward-facing camera (IFC), which can be used to take footage inside the vehicle.
- Both OFC and IFC footage is stored.
- You are responsible to check the laws of your residence before turning on your OFC or IFC (for instance, in some countries consent is required for the use of IFC, and in others OFC is strictly restricted to dashcam purposes).
- For more camera details, see section "Panoramic View System" in this manual.

Permanent Vehicle Transfer to Third Parties and Offline Mode

- In case of a permanent vehicle transfer, i.e., second hand vehicle, or vehicle transfer by a third party for permanent use, it must be noted that any personalization/user settings made via the infotainment system (e.g. address list, navigation system, etc.) can be accessed by the new owner.
- You can also restrict your vehicle's communication with the BYD data server and the processing of vehicle-related and personal data by setting the vehicle to offline mode.

- On the infotainment touchscreen, tap  to turn Wi-Fi off.
- This can also be done by tapping  → **System** → **Connection** → **WLAN** → **OFF**.

Disclosure of Personal Data to Authorities

- BYD will not disclose your personal data to third parties unless this is legally permissible or you have consented to it.
- However, subject to applicable laws, government agencies may be authorized to read out data from vehicles (for example, data can be read from the airbag control unit to clarify an accident).
- If required by law, BYD may also be obliged to disclose data upon request to governmental authorities in your country/region, such as in the investigation of a criminal offence.

Your Data Protection Rights

- BYD has staunch respect for its customer's privacy, and strictly complies with all data protection laws, in particular the General Data Protection Regulation (GDPR) and applicable local laws.
- According to these laws, owners have specific rights when their personal data is processed:
 - Data subjects have the right of information and access, to rectification, erasure of personal data ("right to be forgotten") and the right to object to the processing of

personal data or to restrict it (or to withdraw consent given earlier, as well as the right to data portability).

- These rights may be limited in some cases. For example, if we can show that we have a legal obligation to process your data, or if providing the information to you would disclose personal data about another person, or if we are legally prevented from disclosing that information.
- In some cases, this may mean that we can retain the data even if you withdraw your consent.
- For more information on data processing, data protection, and any rights you may have, please visit the latest version of the Privacy Policy available at the infotainment system (**Vehicle** → **System** → **More** → **Privacy Policy**).

02

INSTRUMENT CLUSTER

Instrument Cluster.....36

Instrument Cluster

Instrument Cluster View























LCD Instrument Cluster





























- | | | | |
|---|-----------------------|----|---------------------------------|
| 1 | Time | 6 | Total mileage |
| 2 | Power meter | 7 | Remaining driving range |
| 3 | Speedometer | 8 | Gear status |
| 4 | State of charge (SOC) | 9 | Drive mode information |
| 5 | Outside temperature | 10 | Energy regeneration information |

Instrument Cluster Indicators

Indicators and Warning Lights

	Turn signal indicator		Position light indicator
	OK indicator		ECO indicator
	SPORT indicator		Lane keeping indicator*
	Discharge indicator		AVH indicator
	HDC indicator*		Cruise control main indicator*
	ACC speed indicator*		ACC status indicator*
	PCW indicator (green)		Regular cruise control indicator*
	ICC indicator*		ELKA status indicator*
	Towing mode indicator*		High beam indicator
	HMA indicator*		Driver monitoring assistance system fault warning light*
	Rear fog light indicator		AVAS fault indicator*

	AEB fault warning light*		Smart key warning light
	Tire pressure fault warning light		Main alarm indicator
	ESC OFF warning light		ESC fault warning light
	ABS fault warning light		Driving power limit warning light
	Headlight fault warning light		Snow mode indicator
	High-voltage battery low SOC warning light		ACC fault warning light*
	BSD indicator*		AVH standby indicator (gray)
	Speed limit release indicator*		ACC standby indicator (gray)*
	Steering system fault warning light		TSR indicator*
	PCW warning light (red)		Powertrain fault warning light
	Seat belt reminder		Airbag fault warning light
	EPB indicator		Parking brake system fault warning light
	Low-voltage power system fault warning light		High-voltage battery charging connection indicator



High-voltage battery fault warning light



High-voltage battery overheating warning light



Coolant overheating warning light

Warning Light/Indicator Description



Smart key warning light

- If the key is not in the vehicle when you press the START/STOP button, this warning light comes on for a few seconds, a beep sounds, and the message "No key detected, please confirm if the key is in the vehicle" is displayed on the instrument cluster.
- If you press the START/STOP button while an electronic smart key matching the model is in the vehicle, this warning light does not light up. The vehicle can now be powered on.
- If the warning light flashes after you press the START/STOP button, it indicates low battery of the key.
- If the key is not in the vehicle, the instrument cluster prompts "No key detected, please confirm if the key is in the vehicle".



Antilock Braking System (ABS) fault warning light

- This warning light comes on when the ignition is on. If the anti-lock braking system (ABS) is working properly, the light goes out in a few seconds. Thereafter, if the system fails, the light lights up again until the fault is cleared.
- When the ABS fault warning light is on (with the parking system fault warning

light off), the braking system continues to operate whereas the ABS does not.

- When the ABS fault warning light is on (with the parking system fault warning light off), since the ABS system does not operate, the wheels will be locked in case of emergency braking or braking on a slippery road.
- If any of the following cases occurs, it means there is a fault in components monitored by the warning light system. In that case, contact a BYD authorized dealer or service provider for vehicle inspection as soon as possible.
 - This warning light does not come on or is steady on when the ignition is on.
 - This warning light is steady on while driving.



REMINDER

- A warning light that lights up briefly during operation does not indicate a problem.
- If the ABS fault warning light is still on while the braking system warning light is on, immediately park the vehicle in a safe place. It is recommended to contact a BYD authorized dealer or service provider. In this case, if brakes are applied, the ABS will not work and the vehicle will become extremely unstable.
- If both ABS indicator and the braking system indicator come on and the

electronic parking brake (EPB) is fully released, the braking force distribution system of front and rear wheels has also failed.



Tire pressure fault warning light

- This warning light comes on when the ignition is on. It turns off in a few seconds if the tire pressure monitoring system is working properly. If the system fails, this warning light turns on again.
- When the tire pressure fault warning light comes on or flashes, the message "Please check TPMS" is displayed on the instrument cluster, and the tire pressure is displayed as "---", it indicates that the tire pressure system is faulty.
- When the tire pressure value displays "No Signal", it indicates that the tire pressure signal at the location of the vehicle may be disturbed or the tire pressure monitoring module is damaged.
- When the tire pressure fault warning light is solid on and one or more values turn yellow on the tire pressure screen on the instrument cluster, the corresponding tire is in under-pressure condition. When the temperature value of one or more tires turns yellow, it indicates that the tire temperature is too high.

In the event of any of the situations above, it is recommended to contact a BYD authorized dealer or service provider for inspection as soon as possible.



ESC fault warning light

- This warning light comes on when the ignition is on. If electronic stability control (ESC) functions properly, the light goes out in a few seconds. If the

system fails, this warning light turns on again until the system fault is cleared.

- If the ESC warning light flashes temporarily while the vehicle is in motion, it indicates the ESC system is working.
- When the ESC warning light turns on (with the ABS fault warning light and the parking system fault warning light off), the ESC fails, but the ABS and the braking system continue to operate normally.
- When the ESC warning light turns on (with the ABS fault warning light and the parking system fault warning light off), the ESC system does not work. This means the vehicle is extremely unstable at sharp turns or when the driver steers away from obstacles ahead.
- If any of the following cases occurs, it means there is a fault in components monitored by the warning light system. In that case, contact a BYD authorized dealer or service provider for vehicle inspection as soon as possible.
 - This warning light remains off (self-check not performed) after the vehicle is powered on.
 - This warning light is steady on while driving.



REMINDER

- A warning light that lights up briefly during operation does not indicate a problem.
- If the ESC warning light remains on while the warning lights for the ABS and the braking system are on, immediately stop the vehicle in a safe place and contact a BYD authorized dealer or service provider. This is because braking at this time can render the vehicle

! REMINDER

extremely unstable, and the anti-lock braking system does not work at all.



ESC OFF warning light

- When the ESC OFF switch is pressed, this warning light should remain steady on and the ESC system will not operate. When the ESC OFF switch is pressed again, this warning light should turn off and the ESC system resumes its normal operation.

! REMINDER

- While the ESC OFF warning light is on, the driver must stay alert and keep driving at a lower speed when making a sharp turn and when avoiding an obstacle which appears suddenly, because braking at this time can render the vehicle unstable, given the malfunction of ESC system.



Driving power limit warning light

When the power of the vehicle is limited, this warning light will come on. In this case, contact a BYD authorized dealer or service provider in time.



Headlight fault warning light

- When the warning light is yellow, it indicates the headlight is faulty, and it is recommended to bring the vehicle to a BYD authorized dealer or service provider for inspection.



Main alarm indicator

- If this indicator goes on, check the fault prompt or warning on the instrument cluster.



Seat belt reminder

- With the ignition switched on, if any passenger on the front seats or rear seats* has not buckled up, the seat belt reminder indicator* lights up. It remains on until the seat belt is fastened.



Airbag fault warning light

- With the ignition switched on, this warning light turns on and then goes off in a few seconds if the airbag system is working properly. This warning light is used to monitor the airbag ECU, collision sensors, inflation device, warning lights, connections, and power supply.
- If any of the following cases occurs, it means there is a fault in components monitored by the warning light system. In that case, contact a BYD authorized dealer or service provider for vehicle inspection as soon as possible.
 - When the ignition is switched on, this warning light remains off or is solid on after the ignition is switched on.
 - This warning light turns on during driving.



Parking system fault warning light

When the brake fluid level is low and the braking system is faulty, this warning light lights up. If any of the following conditions occurs, immediately park the

vehicle in a safe place. It is recommended to contact a BYD authorized dealer or service provider.

- This warning light comes on when the ignition is switched on and the brake fluid level is low.

REMINDER

- When the brake fluid level is low, park the vehicle because it is dangerous to continue driving.
- This warning light is solid on although after starting the vehicle, the brake fluid level and EPB system operation are normal (the EPB is engaged and released normally, and the message "Please check the EPB" is not displayed).
- Fault warning lights for parking brake and ABS come on simultaneously.

REMINDER

- A warning light that lights up briefly during operation does not indicate a problem.

 Steering system fault warning light

- When the steering system is faulty, this warning light is steady on. It is recommended to bring the vehicle to a BYD authorized dealer or service provider for inspection.

REMINDER

- The steering system features an electric motor to reduce the force required to turn the steering wheel.
- When turning the steering wheel, a hum may be heard from the

REMINDER

running motor. This does not indicate that the motor is faulty.

- Do not turn the steering wheel to its limit position for more than five seconds, otherwise the temperature protection will be activated and the steering system will be damaged or steering will become heavy.
- If you have turned the steering wheel frequently with the vehicle staying put for a long time, the steering wheel may become difficult to turn even if the warning light does not turn on. This is not a fault.
- To prevent steering system overheating, the power assist effect will be reduced if the steering wheel has been frequently turned with the vehicle staying put for a long time. As a result, the steering wheel become difficult to turn. In this case, reduce steering frequency or power off the vehicle. The system will recover within 10 minutes.

WARNING

- If the steering system warning light goes on, immediately park the vehicle safely, and contact a BYD authorized dealer or service provider.

 Low-voltage power system fault warning light

- This light is used to warn about the operating state of the DC module and the low-voltage battery module when the vehicle is not being charged or discharging.

- In charging state, this warning light indicates failure of the charging system.
- If this warning light turns on while the vehicle is in motion, it indicates that there is a problem with the DC system or the low-voltage power system. In this case, turn off the A/C and fans, immediately park the vehicle safely, and contact a BYD authorized dealer or service provider.



Powertrain fault warning light

- If the powertrain fails, this warning light turns on.
- If any of the following cases occurs, it means there is a fault in components monitored by the warning light system. In that case, contact a BYD authorized dealer or service provider for vehicle inspection as soon as possible.
 - This warning light is steady on when the ignition is switched on.
 - This warning light turns on during driving.



CAUTION

- Try not to drive the vehicle when the warning light is on. Contact a BYD authorized dealer or service provider to check the problem as soon as possible.



High-voltage battery overheating warning light

- If this indicator is on, it indicates that the high-voltage battery temperature is too high and the vehicle must be stopped to cool down. When the warning light flashes, it is recommended to immediately stop the vehicle safely and leave the vehicle as soon as possible.

- The high-voltage battery may overheat under the following operating conditions:
 - Driving up a slope for a long time in hot weather.
 - Long period of stop-and-go traffic condition, frequent rapid acceleration, frequent hard braking, or vehicle running for a long time without pause.











High-voltage battery fault warning light

- This warning light comes on when the ignition is switched on. If the high-voltage battery system is working properly, this warning light will turn off in a few seconds. Thereafter, if the system fails, this light will light up again. It is recommended to contact a BYD authorized dealer or service provider for inspection as soon as possible.
- If any of the following cases occurs, it means that there are faults in the components monitored by the warning light system. In such case, it is recommended to contact a BYD authorized dealer or service provider for vehicle inspection as soon as possible.
 - This warning light is steady on when the ignition is on.
 - This warning light is steady on or occasionally turns on while driving.

Other Instrument Cluster Fault Prompts

The instrument cluster may display the following fault prompts. Handle them as recommended.

Symbol	Error message	Response
	Please check the OBC system	The on-board charging system is faulty. In this case, check the charging connection, and reconnect the charging equipment. If the fault persists, contact a BYD authorized dealer or service provider.
	Vehicle network error, please pull over safely and contact BYD service	The vehicle may be disconnected from the network. In this case, park the vehicle safely, and contact a BYD authorized dealer or service provider.
	Please check the headlamp system	The headlight is faulty. In this case, contact a BYD authorized dealer or service provider.
	Please check the PCW system*	The PCW system is faulty. In this case, park the vehicle, and contact a BYD authorized dealer or service provider.
	The AEB function is limited*	The AEB system is faulty. In this case, park the vehicle, and contact a BYD authorized dealer or service provider.
	Please check the BSD system*	The BSD system for lane change is faulty. In this case, park the vehicle, and contact a BYD authorized dealer or service provider.
	The BSD function is limited*	The BSD function is limited. In this case, park the vehicle, and contact a BYD authorized dealer or service provider.
	Please check the gear	The shifter controller is faulty. In this case, park the vehicle immediately, and contact a BYD authorized dealer or service provider.
	Please check the multi-purpose camera*	The multi-purpose camera is faulty. In this case, park the vehicle, and contact a BYD authorized dealer or service provider.
	The function of the multi-purpose camera is limited*	The function of the multi-purpose camera is limited. In this case, park the vehicle, and contact a BYD authorized dealer or service provider.
	Intelligent-camera is not available due to poor condition*	The intelligent-camera is unavailable. In this case, park the vehicle, and contact a BYD authorized dealer or service provider.

Symbol	Error message	Response
	Please check the LDWS*	The lane departure warning system (LDWS) is faulty. In this case, park the vehicle, and contact a BYD authorized dealer or service provider.
	Please check the ICC or LKS*	The intelligent cruise control (ICC) or lane keeping system (LKS) is faulty. In this case, park the vehicle, and contact a BYD authorized dealer or service provider.
	The function of the ICC or LKS is limited*	The ICC or LKS function is limited. In this case, park the vehicle, and contact a BYD authorized dealer or service provider.

03

CONTROLLER OPERATION

Doors and Keys.....	48
Seats.....	59
Steering Wheel.....	62
Switches.....	65

Doors and Keys

Keys

The vehicle is equipped with keys, including electronic smart key, mechanical key (installed in the electronic smart key) and NFC key*.

Smart Key

Press the front door microswitch, while carrying the smart key, to unlock or lock all doors, or press smart key buttons to lock/unlock doors, open the trunk, or start the vehicle remotely.

- ① Indicator
- ② Lock button
- ③ Unlock button
- ④ Trunk release button
- ⑤ Start/Stop button
- ⑥ Mechanical key

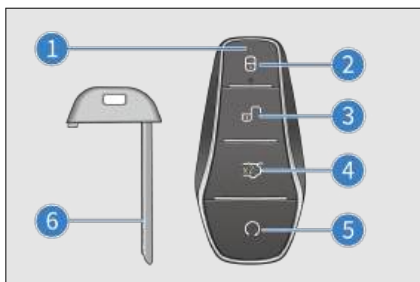

! WARNING

- The button (coin) battery in the smart key is hazardous and both new and used batteries are to be kept away from children at all times.
- If swallowed or placed inside any part of the body, a lithium button

! WARNING

battery can cause severe or fatal injuries in two hours or less.

- Medical attention should be sought immediately if it is suspected the button battery has been swallowed or placed inside any part of the body.

! CAUTION

- The smart key is an electronic component. Observe the following instructions to prevent damage to the key:
 - Do not expose the smart key to high temperatures, such as on the dashboard.
 - Do not disassemble the smart key.
 - Do not let the smart key hit other objects or fall down.
 - Do not immerse the key in water or clean it in the ultrasonic scrubber.
 - Do not place smart keys with devices that emit electromagnetic waves, such as the mobile phone.
 - Do not attach to the smart key any objects (such as a metal seal) capable of cutting off electromagnetic wave signals.
 - You can register a spare key for the same vehicle. In this case, contact a BYD authorized dealer or service provider immediately.
- If the electronic smart key cannot operate the door within the normal distance, or the key indicator light is dim or off:

⚠ CAUTION

- Check for nearby radio stations or airport radio transmitters that interfere with the normal operation of electronic smart keys.
- The smart key battery may be exhausted. Check the battery inside the electronic smart key. It is recommended to contact a BYD authorized dealer or service provider for battery change.
- If the smart key is lost, contact a BYD authorized dealer or service provider as soon as possible to prevent theft or accidents.
- Do not change the transmission frequency arbitrarily, increase the transmission power (including additional transmission frequency amplifier), or arbitrarily connect the external detection antenna or switch other transmitting detection antennas.
- The use of the smart key must not cause harmful interference to legal radio communication services. Once interference is found, stop using the key immediately and take measures to eliminate the interference before continuing to use.
- The use of micropower radio equipment must be free from interference of all radio services or from radiation of devices for industrial, scientific and medical applications.
- Do not use it near airplanes or airports.
- People implanted with pacemakers or defibrillators should stay away from the detection antennas of intelligent

⚠ CAUTION

- entry and start systems, as electromagnetic waves can affect the normal use of such devices.
- In addition to people implanted with pacemakers or defibrillators, those who use other electronic medical devices should also consult the manufacturer on the use of such devices under the influence of electromagnetic waves. Electromagnetic waves may bring unknown consequences to the use of such medical devices.
- When leaving the vehicle, always carry your key and lock the vehicle. Never leave anyone (especially children) alone in the vehicle.

Mechanical Key

Use the mechanical key (inside the smart key) to lock or unlock the driver's door. Insert the mechanical key back into the smart key when it is not in use.

Taking out the mechanical key

- Press the "PUSH" button ② on the smart key, and take out the mechanical key in the direction indicated by ①.



- To put the mechanical key back, press the PUSH button and then insert the mechanical key.

NFC Key Card

- Hold the NFC key card close to the NFC sign on the left side mirror. Then, all doors can be unlocked or locked when the vehicle is powered off.

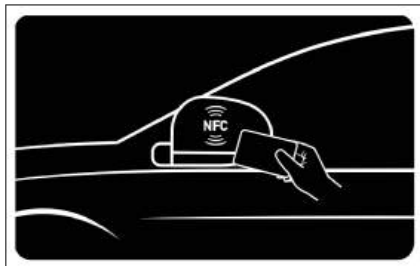

CAUTION

- NFC key card is an electronic product. The following instructions must be observed to prevent function failure of or damage to the card:
 - Do not place the NFC card in the charging area when the wireless charger is on.
 - Do not attach any object (such as a metal seal or metal phone case) that may cut off electromagnetic waves, when using the NFC card.
 - Do not place the NFC card in a position exposed to high temperature, such as on the dashboard.
 - Do not bend the card with force.
 - Do not place the card with other hard objects.
- NFC key cards use near-field communication technology,

CAUTION

requiring a detection distance of less than 2 cm. When identifying, it is recommended to place the NFC card close to the side mirror for 1-2s.

- The NFC smart card is a key configured for the vehicle based on the near field communication method. In order to ensure vehicle safety, handle it with care. If it is lost, going to BYD authorized dealer or service provider for blocking of the lost card and re-configuration is recommended.

Locking/Unlocking Doors

Locking/Unlocking with Mechanical Key

Insert the key into the key hole, turn and remove the key, and pull the door handle to open the door.

- Unlock the driver's door: Turn the key clockwise.
- Lock the driver's door: Turn the key counterclockwise.

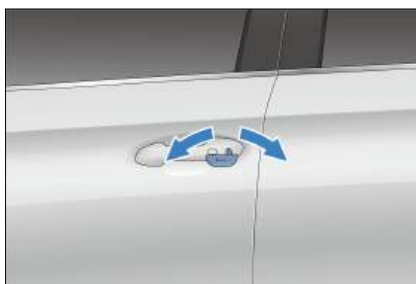

CAUTION

- After removing the mechanical key, pull the driver's door handle to open the door.

Opening with Interior Door Handle

- When the vehicle is unlocked, pull the handle once to open the door from inside the vehicle.
- When the vehicle is locked, pull the handle twice to open the door from inside the vehicle.

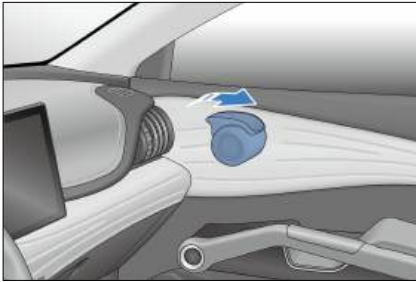
**WARNING**

- Do not allow children to play with the door handle, so as to avoid the door opening while driving.
- If there are children in the vehicle, make sure to enable the child protection lock function.

CAUTION

- As this vehicle is equipped with a child protection lock, the rear doors can only be opened with the interior door handle when the child protection lock is disabled.

Locking/Unlocking with Smart Key

- The wireless remote control is used to unlock or lock all doors at a close distance, and complete additional functions.
- When you enter the active area while carrying a registered smart key, press the button on the smart key slowly and firmly to lock or unlock all doors.

Locking: 

- When the ignition is switched off and all the doors, the hood, and the trunk are closed, press the lock button to lock all the doors. The side mirrors fold in (the switch is set to Automation (AUTO)), and the turn signals flash once. Check whether all doors are securely locked.
- If a door, the hood or the trunk is not closed, the turn signals will not flash, and the horn will sound once.

**Unlocking:** 

- With the doors locked, press the unlock button of the valid smart key. All doors will unlock, side mirrors unfold*, and turn signals flash twice.
- When you unlock all the doors with the smart key, even if no door is opened, the interior lights will stay on for 15 seconds and then go out.
- If the anti-theft alarm system is armed, open any door within 30 seconds after

unlocking with the smart key or all doors will relock automatically.

- If the key is in the vehicle or trunk when the doors are closed and locked, the vehicle will unlock automatically and the turn signals will flash twice.
- When the vehicle is equipped with four-door anti-pinch function, pressing and holding the lock/unlock button to rise/lower the windows, and pressing briefly to lock/unlock the doors.

Opening the trunk with smart key

- Double-press the trunk release button on the smart key. The turn signals then flash twice.

REMINDER

- Remember to carry the smart key when leaving the vehicle.

Finding the Vehicle with Smart Key

- When the vehicle is in anti-theft mode, press the lock button. The vehicle sounds a long beep and turn signals flash 15 times. Use this function to locate the vehicle when it cannot be found.
- When the vehicle is in car search mode, press the lock button again. The vehicle enters the next car search mode.

Locking/Unlocking with Microswitch

Locking

- When the ignition is switched off and all doors are closed but not locked, press the microswitch on the front door handle while carrying the smart key. All doors will be locked and turn signals flash once.
- If a door, the hood or the trunk is not closed, pressing the microswitch

will still lock the closed doors, but the horn will only sound once, and the turn signals will not flash.

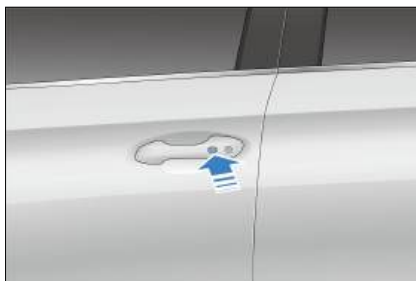

Unlocking

- When doors are locked, press the microswitch on the front door handle while carrying the smart key close to the activated area. All doors unlock and turn signals flash twice.
- If the anti-theft alarm system is armed, open a door within 30 seconds after the unlocking, or all doors will relock automatically.
- Pressing the microswitch does not work if:
 - This is performed while a door is being opened or closed.
 - The smart key is left in the vehicle.

REMINDER

- If the smart key is too close to an exterior door handle or window, it may not be possible to activate the entry function.

Raising/Lowering Windows with Microswitch

- When the ignition is switched off, press and hold the microswitch while carrying the smart key to roll up or down all windows. (To enable or disable this function, go to the

infotainment touchscreen → 🚗 →
Vehicle → Locks.)

Locking/Unlocking with NFC Key

- Hold the NFC card close to the NFC sign on the side mirror on the driver's side.

Locking doors:

- With the ignition switched off and all doors closed but not locked, place the NFC key card close to the designated area on the driver's side mirror to simultaneously lock all the doors. The turn signals flash once.

Unlocking doors:

- With the anti-theft alarm system armed, place the NFC key card close to the designated area on the driver's side mirror to simultaneously unlock all the doors. The turn signals flash twice.
- If the alarm is armed, open a door within 30 seconds after unlocking with the NFC key card, or all doors will relock automatically.
- After the unlocking, user activation permission is provided for four minutes and is revoked when the ignition is switched off.
- Doors will not be locked/unlocked when:
 - The NFC key card is placed close to the designated area on the driver's side mirror while a door is being opened or closed.
 - The ignition is not switched off.



CAUTION

- The keyless start permission lasts for up to four minutes.

Locking/Unlocking the Trunk

Opening/Closing trunk with smart key

- When the vehicle is equipped with the electric tailgate system, double-press the trunk release button on the smart key to open the trunk. The turn signals then flash twice. Press this button again to stop opening. Then double press it to close the trunk.



REMINDER

- If the trunk release button is pressed again while the lid is in motion, it will stop at its current position.

Opening/Closing the trunk from inside the vehicle*

- When the trunk lid is closed, pull the switch once, and the lid will automatically unlock and open to the set height (maximum height by default).
- While the trunk lid is opening, pull this switch again to freeze it in place.

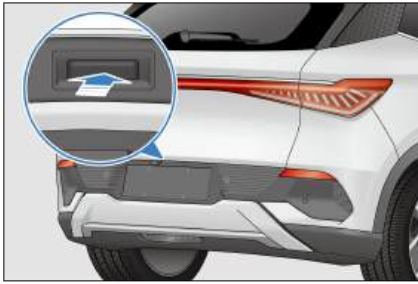

- When the trunk is open and the switch is pulled for more than one second, the lid closes automatically. Release the switch to freeze the closing motion.

Opening the trunk with exterior switch

- With the vehicle unlocked, press the exterior trunk switch to open the trunk.
- With the vehicle locked, unlock the vehicle with the smart key and press the exterior switch to open the trunk.



REMINDER

- If the switch is pressed again while the lid is in motion, it will stop at its current position.

Closing the trunk automatically*

① Trunk close button*

- When the trunk lid is open and stationary, press the trunk close button to close this lid.

- Press this button a second time to stop the lid at the current position. Press this button again to have the lid move in the opposite direction.

② Vehicle lock button*

- When the ignition is off and the trunk is open, pressing the lock switch while carrying a valid smart key closes the trunk, locks the entire vehicle, and arms the anti-theft alarm system.

Closing the trunk manually*

- When the vehicle is unlocked, the trunk can be closed manually.

Opening/Closing trunk with BYD Assistant*

- The trunk can be opened or closed by BYD Assistant after system wake-up.

CAUTION

- Before closing the trunk electronically, make sure doors, windows and sunroof are properly closed.

Emergency Vehicle Locking with Mechanical Key

When the central locking system or the smart key fails, use the mechanical key for emergency locking or unlocking.

Locking

1. Remove the mechanical key from the smart key.
2. Open all doors other than the driver's door and move down the slider with the mechanical key as shown. You can then lock the doors by closing the them.

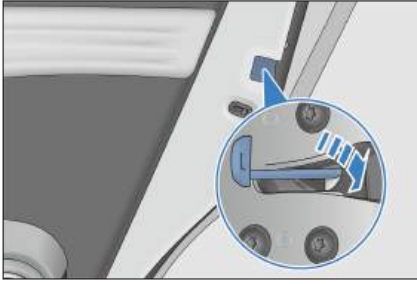

3. After locking the three doors, open the driver's door.
4. Insert the mechanical key into the keyhole, turn it counterclockwise as far as it can go, return it to the initial position and pull it out. (See "Locking/Unlocking with Mechanical Key" **P50** in this Chapter.)

Unlocking

1. Remove the mechanical key from the smart key.
2. Insert the mechanical key into the keyhole, turn it clockwise as far as it can go, return it to the initial position and pull it out.
3. Pull the interior handle twice to unlock the three other doors.

Locking/Unlocking with Central Locking

Locking or unlocking the vehicle with the central locking

See **P72** in "Driver's Door Switches" in this chapter.

Locking or unlocking doors automatically

- When this function has been turned on through the infotainment touchscreen and the ignition has been switched on, if the vehicle speed increases to over 8 km/h with all doors closed but any of them unlocked, the central locking locks all doors with power.

- Press the START/STOP button to switch the ignition off and then all doors are unlocked automatically.

Locking/unlocking all doors concurrently

- With the anti-theft alarm system disarmed, the backlight of the central lock button turns on if the vehicle is locked and off if the vehicle is unlocked.
- Pressing the central locking button locks all doors so that any attempt to open any door from the outside fails. At this time, pull the interior door handle to unlock a door and pull a second time to open it.

Emergency Trunk Releasing from the Inside

- There is an emergency unlocking cover just above the trunk lock. Open the cover and pull the emergency unlocking rope or lever to open the trunk in an emergency.

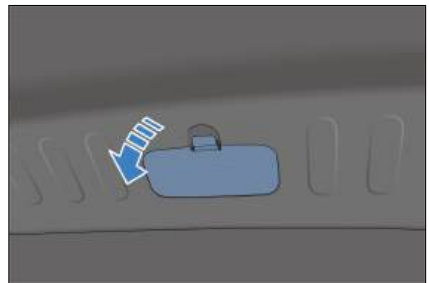

! REMINDER

- When the vehicle is powered off, the trunk can be unlocked from the inside in case of emergency.

Setting trunk opening height*

- Open the trunk manually or automatically to the desired position, keep it at this position, and then press

and hold the interior trunk button for over three seconds. The speaker sounds for one second, indicating that the opening height is successfully set to the current position.

- Set the trunk opening height in  → **Vehicle** → **Locks**.

Anti-pinch function

- The trunk will open or stop moving if it contacts any obstacle while closing or opening.

When the trunk fails to act automatically

- Manually and completely close the trunk for recovery.

When reconnecting the low-voltage battery

- Manually close the trunk to ensure the power trunk lid functions normally.

WARNING

- In order to prevent serious injury, make sure to observe the following precautions:
 - Never try to deliberately activate the anti-pinch function.
 - Make sure to alert people nearby of the lid motion.
 - Make sure hands and fingers are clear from the lid area when it is closing.
 - Make sure the surrounding area is safe when opening or closing the trunk.
 - Make sure the trunk is properly closed before driving the vehicle.
 - Make sure to remove any ice or snow from the area before opening the trunk, otherwise the lid may close again.

WARNING

- Do not manually interfere in lid motion when it is opening or closing.
- Be mindful of windy conditions when opening or closing the trunk.
- The anti-pinch function may fail to work if an object is caught right before the trunk is fully closed.
- The lid may start closing before fully opening. Opening or closing the trunk on slopes is more difficult than on level ground. Be mindful of the possibility of the lid to move on its own in such conditions. Before loading or unloading the trunk, make sure the lid is fully open and secure.
- The anti-pinch function may fail depending on the object shape. Be especially careful about hand and fingers.

Raising/Lowering Windows with Smart Key

- When the ignition is switched off:
 - Press and hold the lock button on the smart key to raise the four windows.
 - Press and hold the unlock button on the smart key to lower the four windows.

WARNING

- When using the remote control function to raise windows, pay attention to the safety of occupants in the vehicle, and use this function only after making

WARNING

sure the windows are clear from pinching anyone.

REMINDER

- To enable or disable key unlock/lock/closing window functions, go to  → **Vehicle** → **Locks**. (Configurations of the actual vehicle prevail.)

Smart Access and Start System

Use the smart key to unlock or lock the vehicle doors and start the vehicle.

Access

Use the smart key to unlock or lock the vehicle doors (See **P51** for details)。

Start-up

With the smart key inside, press the brake pedal and the START/STOP button to start the vehicle (See **P107**).

Antenna positions

- ① Interior antenna
- ② Exterior antenna

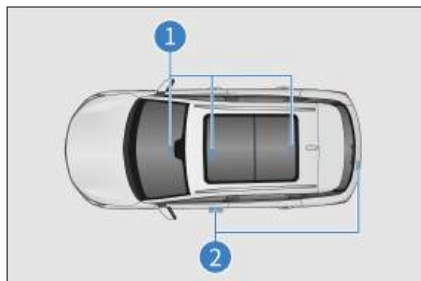

Active area

The smart access and start functions take effect only when the registered smart key is within the active area.

- ① Active area of the access function: about one meter from the front door handle and the exterior trunk switch.
- ② Active area of the start function: inside the cabin.

If another smart key is near this vehicle's smart key, unlocking may take longer than usual, which is normal.



REMINDER

In the following situation, smart access and start system may not work normally:

- There is a strong electromagnetic field nearby, such as TV towers, power stations, and broadcasting stations.
- The smart key is being carried along with a communication device, such as a two-way radio or mobile phone.
- The smart key is in contact with or covered by a metal object.
- The door handle is operated too quickly.
- The smart key is too close to the handle.

! REMINDER

- Another wireless remote control function is being used nearby.
 - When the smart key battery runs out.
 - The smart key is close to high-voltage equipment or equipment that produces noise.
 - The smart key is being carried along with another smart key or radio-wave-emitting device.
 - Even within the active area, the smart key may not work properly in certain locations, for example, on the dashboard, in the glove box, or on the floor.
- If the smart access system is not working properly and it is impossible to enter the vehicle, the mechanical key can be used to lock/unlock the driver's door, or the wireless remote control function can be used to lock/unlock all doors.
 - Pressing the Start/Stop button may not enable the start function due to:
 - Smart key failure. If the smart key warning light comes on and a message ("Low key battery, please replace the battery soon") is displayed on the instrument cluster, the battery of the key may be exhausted.
 - If the smart access and start system cannot work properly due to system failures, bring all smart keys to a BYD authorized dealer or service provider for repair.

Saving battery power

- The smart key communicates with the vehicle even when the vehicle is not running. Therefore, do not leave the

smart key in the vehicle or within two meters from the vehicle.

- Receiving strong electromagnetic waves for a long time drains the battery of the smart key quickly. The smart key must be kept at least one meter away from electrical equipment that generates a magnetic field, such as the following devices:
 - TVs
 - PCs
 - Phone charger
 - Electroliers
 - Fluorescent desk lamps

Child Protection Lock

Child protection locks are designed to prevent children in rear seats from accidentally opening rear doors. Such locks are provided on the sides of the left and right rear doors.

- ① Activating the child protection lock
- ② Deactivating the child protection lock

When the child protection lock is activated, the rear doors cannot be opened from inside. The rear doors can only be opened with the exterior door handles.

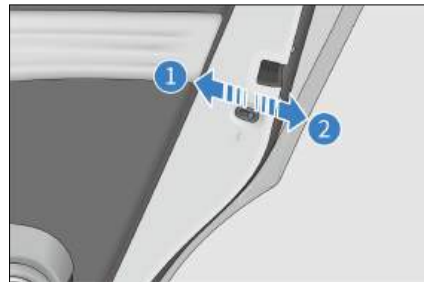

CAUTION

- Before driving, especially when a child is in the vehicle, ensure that the doors are closed and the child protection lock function is enabled.
- Proper use of seat belts and the child protection lock helps prevent the driver and passengers from being thrown out of the vehicle in the event of an accident, and prevent the doors from being opened accidentally.

Seats

Adjusting Front Seats

Adjusting Front Seat with Power*

Power front seat adjustment include seat position adjustment, cushion height adjustment*, and seatback angle adjustment. Choose the following methods according to the actual configuration of your vehicle.

① Seat position adjustment switch

- Toggle the seat position adjustment switch back or forth to move the seat backward or forward.
- Move the rear end of the switch up or down to raise or lower the seat.

② Seatback angle adjustment switch

- Toggle the upper end of the seatback angle adjustment switch to adjust the seatback angle.

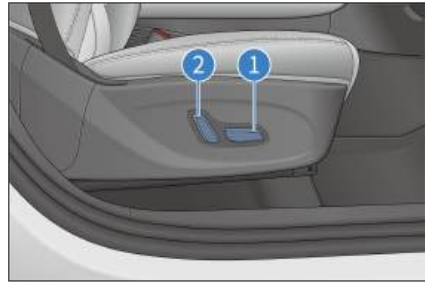

CAUTION

- Releasing the switch stops the seat in this position. Do not place anything under the seat as this may prevent the seat from operating.
- Do not move the front seats too far forward to avoid contact with the roof or sun visor.

Ventilation and Heating System*

- Tap the corresponding controls on the infotainment touchscreen to enable and disable front seat heating or ventilation.
- Find the seat heating setting and ventilation buttons from the drop-down menu on the infotainment homepage.

Heating adjustment

- Seat heating: Control the operation mode of the heating pad by using the seat heating switch. The heating function has two modes.
 - After each power-on, the driver's seat remembers the last mode, and the initial heating state of the passenger's seat is Off.
- Tap the button to select the operation mode of the seat heater in the 1st gear or 2nd gear.

- Tap OFF to deactivate the heating function.

Ventilation adjustment*

- Seat ventilation: Control the operation mode of the ventilation fan by using the seat ventilation switch. Seat ventilation has two modes.
- After each power-on, the driver's seat remembers the last mode, and the initial ventilation state of the passenger's seat is Off.
- Tap the button to select the operation mode of the seat ventilation in the 1st gear or 2nd gear.
- Tap OFF to deactivate the ventilation function.

Ventilation and heating functions cannot be turned on at the same time.

- Press the heating switch to make the heater work; if the ventilation switch is then pressed, the heater will stop and the ventilator will start to work.
- Press the ventilation switch to make the ventilator work; if the heating switch is then pressed, the ventilator will stop and the heater will start to work.

Seat Precautions

- Adjust the driver's seat so that the pedals, steering wheel, and dashboard controls are within the driver's easy control.
- While driving, the most effective safeguard is to keep the seatback upright, always rest well on the seatback, and adjust the seat belt to the right position.
- Rear seats* cannot be folded with the vehicle running.

- Secure your luggage appropriately to prevent it from skidding or moving. Luggage in the vehicle should not be higher than seatbacks.
- The head support can only protect your head when it is in the proper position. Remember to adjust it to the proper position if it has been moved.

WARNING

- Sitting on a folded seatback or on cargo is prohibited. Improper seating position or improperly fastened seat belts can result in severe personal injury in case of emergency braking or a collision.
- Do not place any items under the seats. The driver may lose control of the vehicle because items placed there affect the seat locking mechanism or accidentally push up the seat position adjustment lever, causing the seat to move suddenly.
- When adjusting the seat, do not place your hand under the seat or near its operating parts, to prevent being crushed.
- After adjusting the seatback, lean back to confirm the seatback has been locked. Seatbacks that are not fully locked can cause personal injuries in an accident or during emergency braking.
- Do not put the seatback down while driving or riding in the vehicle. This makes the shoulder strap of the seat belt not properly attached to the body. As a result, occupants could hit the strap in an accident, causing serious injuries to the neck or other parts; or they may slip out of the waist belt, resulting in other serious injuries.

WARNING

- Do not adjust the driver's seat while the vehicle is in motion, as unpredictable seat movement can cause the loss of vehicle control at this time.
- Do not drive the vehicle until occupants are seated properly.

CAUTION

- Adjust the seat position before fastening seat belts.
- While adjusting a seat, do not let it hit against any passenger or the luggage.

Folding Rear Seats

- Flipping and lowering the seatback
- Pull the cord to straighten the seatback.
- Push the seatback forward/backward to fold it. You can fold the seatback forward until the back touches the cushion, or you can fold it backward until reaching the locking position (with a locking click).

**Head Supports****Adjusting Head Supports**

- Lifting a head support

Lift the head support to a proper position, and release it after hearing a locking sound.

- Lowering a head support

Press and hold the head support adjustment button, lower the head support to a proper position, and then release the button after hearing a locking sound.

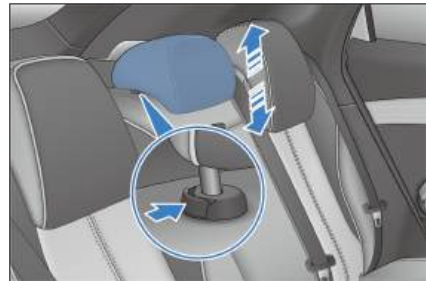

- Removing a head support

Press and hold the head support adjustment button, remove the head support, and release the button.

- Installing a head support

Insert the head support post into the bushing with the grooves facing forward. Press the head support adjustment button, push down the head support to a proper position, and then release the button.

REMINDER

- Head supports protect vehicle occupants from head and neck injuries. Adjust the head support so that its center aligns with the back of your head for

! REMINDER

maximum protection. Adjust the head support to the proper position based on your actual height.

- When adjusting head support height, align the occupant's ear tip line with the center line of the head support.
- After adjusting the head support, ensure that it is locked into position.
- Do not drive the vehicle without head supports.

! REMINDER

- Do not attach any objects to the head support levers.

Steering Wheel

Adjusting the Steering Wheel

Steering Wheel Switches



1 Panoramic view*

2 Screen mode

8 Call

9 Speech recognition

- | | | | |
|---|---|----|-------------------------|
| 3 | Cruise control switch or +/Reset or -/Set | 10 | Right |
| 4 | Distance +* | 11 | Mode |
| 5 | Rocker switch | 12 | Scroll button |
| 6 | Distance -* | 13 | Instrument cluster/Back |
| 7 | ICC | 14 | Left |

The audio control switch is operational when the ignition is switched on.

Left-hand buttons

Panoramic view*

- Turns panoramic view off if already in panoramic view mode, or on if not in panoramic view mode.

Screen mode

- Switches between the landscape and portrait mode of the infotainment system touchscreen.

Cruise switch*

- Turns the cruise system on or off.

+/Reset*

- Activates the Adaptive Cruise Control(ACC) system and uses the previous system settings.

-/Set*

- Sets the current speed to the target cruise speed.

Distance +*

- With ACC enabled, increases the time-based distance from the preceding vehicle by one level each time it is pressed. Up to four levels can be set.

Distance -*

- With ACC enabled, reduces the time-based distance from the preceding vehicle by one level each time it is pressed. Up to four levels can be set.

ICC

- Turns ICC on or off.

REMINDER

- For instructions on using cruise control, see **P62** and **P62**.

Right-hand buttons

Scroll button

- Adjusting infotainment system volume when the instrument cluster is not in menu mode:
 - Roll the button upward to increase the volume. The button is non-operational when the volume reaches the highest.
 - Roll the scroll button downward to decrease the volume. The button is non-operational when the volume reaches the lowest.
- Press down the button to mute. To release the mute state, press down the button again or operate the mute icon on the shortcut menu.
- When the instrument cluster is in menu mode:
 - Roll the button upward to select the upper level-2 or level-3 menu items when the instrument cluster is in the menu mode.
 - Roll the scroll button downward to select the lower level-2 or level-3

menu items when the instrument cluster is in the menu mode.

- Press down the button to go to the next-level menu or confirm the current setting.

CAUTION

- The infotainment system is muted once the instrument cluster is set to the menu mode. To adjust infotainment system volume, exit the instrument cluster menu mode first.

Left/Right buttons

- When the infotainment system is in radio mode:
 - Press the ◀ button to select previous radio station.
 - Press the ▶ button to select next radio station.
- When the infotainment system is in USB/Bluetooth music/third-party music app/other modes:
 - Press the ◀ button to play the previous track (track number -1).
 - Press the ◀ button to select a record upward on the Bluetooth call record or phonebook screen.
 - Press the ▶ button to play the next track (track number +1).
 - Press the ▶ button to select a record downward on the Bluetooth call record or phonebook screen.
- When the instrument cluster is in menu mode:
 - Press the ◀ button to switch to level-1 menu and its submenus on the left.

- Press the ▶ button to switch to level+1 menu and its submenus on the right.

Call

- Press this button to make or receive a call. (The audio system is muted at the same time).
- When a Bluetooth-unrelated screen is currently displayed, press this button to switch to the phone selection screen if Bluetooth is disconnected, or to the Dial screen if Bluetooth is connected.
- After entering a phone number on the Dial screen or selecting a record on the Call Log or Contacts screen, press this button to dial the number.
- When Bluetooth is connected, but no phone number is entered on the Dial screen, press this button to switch to the Call Log screen. Press this button again to call the first dialed number on the call history.

Speech recognition

- Press this button for the infotainment touchscreen to switch to the voice recognition screen.
- Press a second time to exit the screen.

Instrument cluster/Back

- When the instrument cluster is not in the menu mode, press this button to view the instrument cluster menu.
- When the instrument cluster is in menu mode, press this button to return to the upper-level screen, or to exit the menu if there is no upper-level screen.
- When on the Bluetooth call screen, press this button to end the call.

Mode

- Selecting a mode: Press the Mode button to switch between media apps,

peripherals, and pre-installed third-party audio/video apps.

- If speakers are turned off, press this button to turn them on and enter the memory playback mode, or switch to the radio mode if there is no playback source (for example, no external audio equipment) in the memory playback mode.

Horn

- Press the horn button area to honk the horn, and release to stop honking.

CAUTION

- Avoid pressing honking for too long, as the horn may be damaged.

REMINDER

- Observe the traffic laws and use the horn properly.

Adjusting the Steering Wheel Manually

To adjust the steering wheel position, hold it and operate as follows:

- Press the steering wheel adjustment handle, move the steering wheel to the desired angle, or adjust it to the desired axial position, and restore the handle to the locked position.

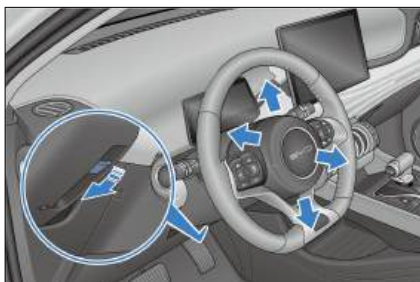

WARNING

- Never adjust the steering wheel while driving, as this is under risk of impaired vehicle control, which can lead to accidents.
- After adjusting the steering wheel, move it up and down to verify that it is securely locked.

Steering Assist Mode Settings

- The level of steering assistance can be adjusted to individual preferences.
- To set the steering assist mode, go to  → **Vehicle** → **Intelligent Chassis** → **Steering Assist Mode**, and select the **Comfortable** or **Sport** mode.

REMINDER

- Setting the power steering to sport mode is suggested if the steering wheel feels light when the vehicle is running at a high speed.

Switches

Light Switches

Set the light switch to  to turn off all lights except for daytime running lights.

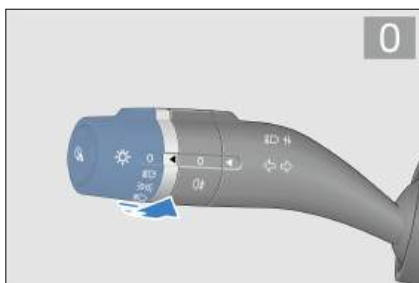

Auto lights

Set the light switch to . The body control module captures the brightness data from the light intensity sensor to automatically turn the position lights and low beam on or off.

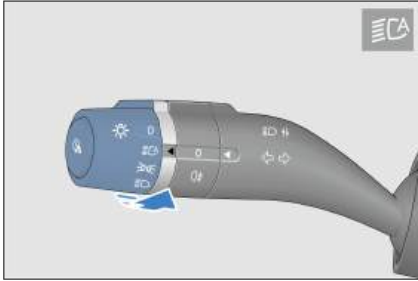

CAUTION

- The light intensity sensor is located at the top of the dashboard panel. Do not block the sensor or let anything splash on it

Position lights

Set the light switch to  to turn on position lights and license plate light.

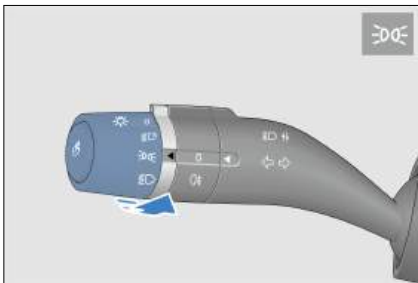

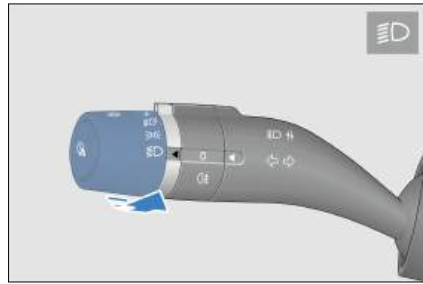

Low beam

Set the light switch to  to turn on the low beam.



Rear fog lights

Set the light switch to  and rotate the fog light dial to  to turn on rear fog lights.

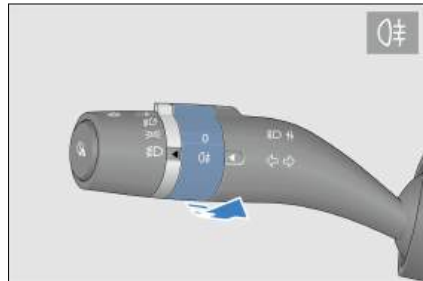

High beam

Set the light switch to  and push the lever from the normal position forward (away from the steering wheel). After the lever is restored to the initial position, high beam is activated and the high beam indicator lights up on the cluster. Pull back the lever, turn off low beam, or exit OK status to deactivate high beam.

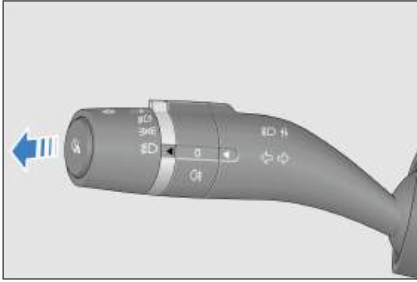

Overtaking light

Pull up the lever (toward the steering wheel) to turn on the overtaking light. Release the lever for the light switch to automatically reset. The overtaking light turns off.

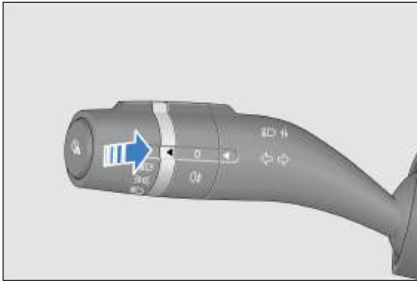

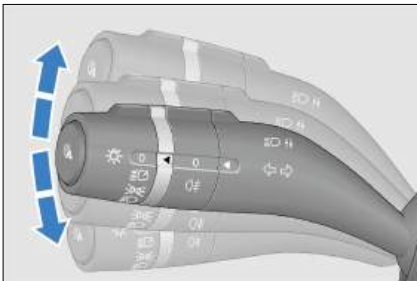

Turn signals

- Push up the lever to signal right turn. The right turn signal and its indicator on the instrument cluster flash.
- Pull down the lever to signal left turn. The left turn signal and its indicator on the instrument cluster flash.







- Once turned on, turn signals continue flashing even after the lever is released. They will turn off after the turn is complete. Depending on the driver's habit, the turn signal will reset after the vehicle turns around under some extreme conditions.

Auto light off

- Conditions to activate the auto light off function: To activate this function, set the light switch to  or  and switch off the vehicle power.
- When the function is activated, the headlights and position lights turn off in 10 seconds if the driver's door is closed.
- When the function is activated, the headlights and position lights turn off in 10 minutes if the driver's door is open.
- After the lights turn off automatically, if the light status changes, these lights come on in the new status. If the conditions to activate the auto light off function are still met, the function is activated again.
- Disabling of the auto light off function: When the vehicle is powered on, the auto light off function is disabled, and the light switch can be operated normally.
- If the auto light off function has turned off the lights and the anti-theft alarm system has been armed, disarming the alarm system makes the lights come on again automatically. If the driver's door remains closed, the lights go off again after 10 seconds. But if any door is open, it turns off the light in 10 minutes.
- Follow me home headlight:
 - The lighting delay is 10 seconds by default and can be set on

the infotainment touchscreen. With the light switch set to ,

, or , when you power off the vehicle, lock four doors, and are leaving the vehicle, the corresponding lights keep on for 10 seconds (or the set time period).

- Headlights before entering:
 - The lighting delay is 10 seconds by default and can be set on the infotainment touchscreen. With the light switch set to , ,
 - or , when you unlock and are approaching the vehicle, the

corresponding lights keep on for 10 seconds (or the set time period).

Adjusting Headlight Height

When the low beam is on, tap  → **Vehicle** → **Lights** → **Headlight Height** on the infotainment touchscreen to adjust the vertical beam angle of the headlights.







Loading Conditions	Recommended Lighting Level
One person in the driver seat	0~2
The driver and the front passenger	0~2
All the seats occupied	0~2
All seats occupied, plus an evenly distributed load in the trunk	1~3
Driver, plus an evenly distributed load in the trunk	1~3

- Vehicle loading conditions may differ. Adjust accordingly.

-  : Point-wiping

Wiper Switch

- The lever is used to control the windshield wipers and washer. It has five modes:
 -  : Fast
 -  : Slow
 -  : Intermittent
 -  : Off

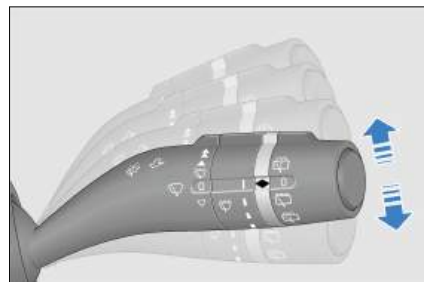

- Push up or pull down the lever to select a mode.

- In slow and fast modes, the wiper operates continuously.
- Pulling down the lever from the 0 position activates the point-wiping mode ▽. The wipers wipe at a low speed until you release the lever.
- The INT knob determines the frequency at which the intermittent mode wipes.

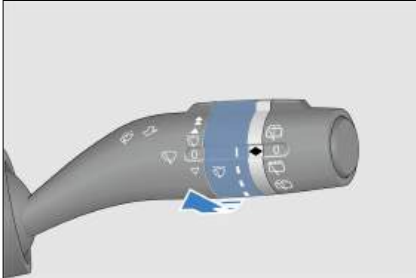

Front windshield washer

- To clean the front windshield, pull the switch lever backward (towards the steering wheel) so that the washer sprays washing fluid while the wipers operate.
- The washer spray will stop when the stick is released, or when it is held for over 10 seconds. The wipers will operate once or twice further after the spray has stopped, and once more after five seconds to remove excess water.

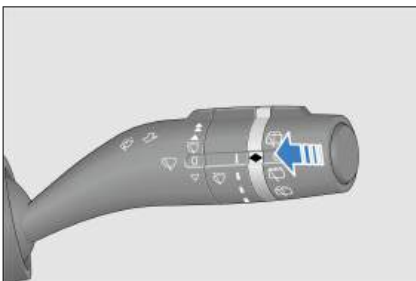

Rear Windshield Wipers and Washer

- Set the wiper switch to ▽ to activate the rear windshield wiper; set it to 0 or open the trunk to stop the wiper.

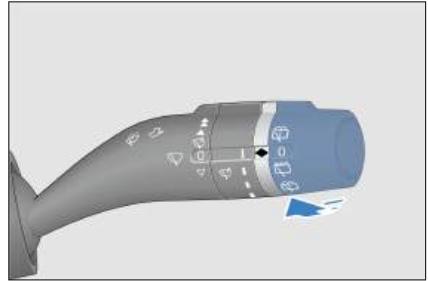

- Set the wiper switch to ▣ to activate the rear windshield wiper and washer simultaneously.

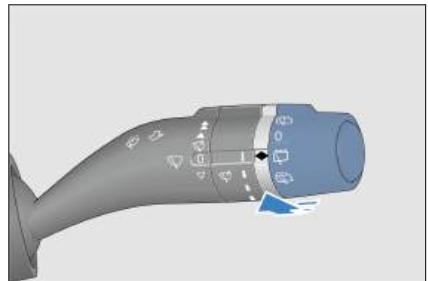

- Set the wiper switch to ▣ and release it. The wiper will operate once or twice after washing fluid has been sprayed.

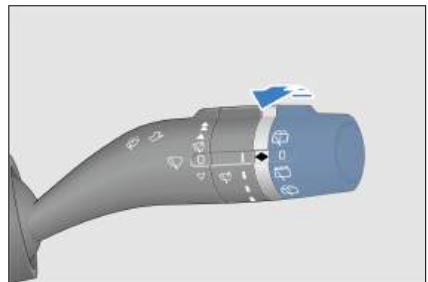

Link between rear wiper and trunk

- The wiper/washer won't work with the trunk opened and the vehicle powered on. If the wiper is working and the trunk is opened, it will stop and resume operation five seconds after the trunk is closed. If the front wiper is operating and the gear is shifted to "R", the rear wiper will be automatically activated.

CAUTION

- Do not operate the washer for over 10 seconds, or when the washer fluid tank is empty, as those may cause motor overheating or damage.

REMINDER

- Check and clean the wiper blades at regular intervals.
- Do not start the wipers while rain is starting, as the windshield cannot be cleaned and rainwater mixed with sand and dust may instantly blur your view, affecting driving safety.
- Use cleaning agent for glass. The use of water, or another type of detergent, may damage the washer motor.

Replacing Wiper Blades

When the vehicle is powered on, enable or disable the front/rear wiper check on the infotainment touchscreen →  → **Service** → **Overhaul**. When the corresponding wiper check function is enabled, the wipers rotate out automatically for easy maintenance and replacement.

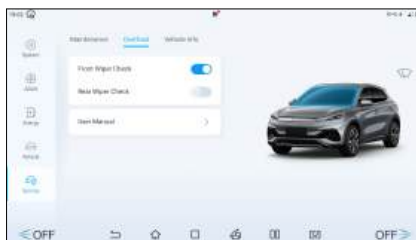

Replacing front wipers

1. Pull up the wiper arm at the driver side, and then pull up the other at the passenger side.
2. Press the wiper lock button ①.
3. Hold the wiper blade and pull it out along the indicated direction ②.
4. When installing a new wiper blade, follow the reverse procedure.

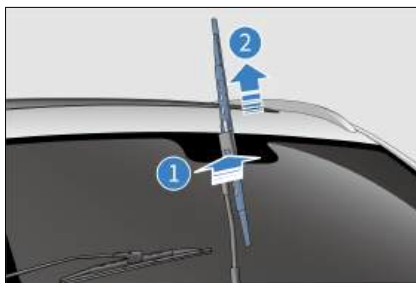

Replacing rear wiper

1. Pull up the wiper arm.
2. Hold the wiper in position ①, and pull the blade out vertically along the indicated direction ②.
3. When installing a new wiper blade, follow the reverse procedure.

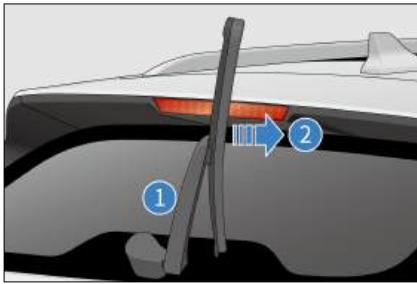

! CAUTION

- Do not open the hood when the wiper arms are pulled up, as this may damage the hood and wiper arms.
- Lower the wipers slowly and avoid direct impact onto the windshield.
- Do not bend the wiper blade, and do not obstruct the wiper blade when the wiper is in operation.
- When replacing the wiper blade, after raising the wiper arm, hold it steady and gently lower it after replacing the wiper blade. Otherwise, before the wiper blade is installed, any external force could make the wiper arm snap back on the glass and risk breaking it.

Driver's Door Switches

Power Window Switches

- When the ignition is ON, all the window switches can roll up or down the window. After the vehicle is powered OFF, no power windows can be regulated.
- The window control switch at the driver's side contains four buttons to roll up or down windows on four doors, respectively.

- Press a switch to roll the window down.
- Pull a switch to roll the window up.
- While using the switch, release it to stop window halfway.

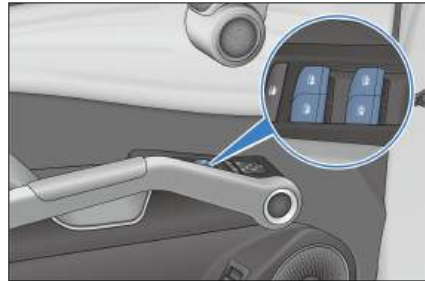

- Rolling down: Press a switch to the second notch and release. The corresponding window rolls down automatically.
- Rolling up: Pull a switch to the second notch and release. The corresponding window rolls up automatically.
- To stop the window halfway, gently push the switch in the opposite direction.

Delay function*

- After the vehicle is powered off, if the front doors are not open, the four-door window controller has a 10min delay period. During this period, the windows can still be rolled up and down.
- If a front door is opened, the window switches won't work.

Smart window control function*

- Smart Key: This function can be enabled in the infotainment system. When the remote control key unlock button is pressed and held, the windows will roll down automatically. When the lock button is pressed and held, the windows will roll up automatically. If the button is released

while windows are in motion, they will stop.

- **Microswitch:** This function can be enabled in the infotainment system. When the microswitch is pressed and held while carrying the smart key, the windows will roll down automatically. When the microswitch is pressed and held again, the windows will roll up automatically. If the button is released while windows are in motion, they will stop.
- If functions are disabled in the infotainment system, and when the switch status is OFF, all windows will roll up when the vehicle is locked.

WARNING

- Before closing a power window, ensure occupants' hands are not placed upon the window glass; pinching of hands can result in serious injuries.

Anti-pinch Function

If someone or an object is caught by the window when it is rolling up, the window stops and rolls down automatically.

Initialization of anti-pinch function

- Close the window, release the switch, and then operate the switch and hold it for at least 400 ms.

WARNING

Please follow the precautions below to prevent serious injury or death from window closing:

- Before operating the power windows, ensure that all passengers do not have any body

WARNING

parts that can be caught in the window.

- Do not allow a child to operate the power windows.

CAUTION

- Excessively frequent activation of the anti-pinch function can activate the regulator motor's overheat protection.
- Do not intentionally activate the anti-pinch function by jamming any part of your body into the window.
- If the low-voltage battery is disconnected while a window is being rolled up or down, the automatic rolling-up and anti-pinch functions both cease to work.
- The anti-pinch function may not work if an object is jammed into the window when it is almost completely closed.
- Contacting a BYD authorized dealer or service provider for maintenance is recommended if the windows' automatic closing function or anti-pinch function is not working normally.

Central Locking

- The driver's door is equipped with power door lock switches to lock or unlock all doors.

① **Locking**

- Press the central lock button. All doors are locked and the red lock indicator lights up.

② **Unlocking**

- Press the central unlock button. All doors are unlocked and the red lock indicator turns off.

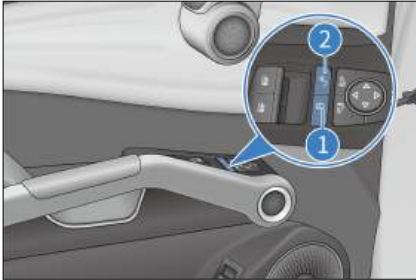

- All doors unlock automatically when the vehicle suffers a strong impact, depending on the impact intensity and accident type.

Window Lock Button*

- Pressing this button deactivates the window switches on the rear row. The window switches on the sides of the driver and the front passenger remain operational.
- Press the switch a second time. The indicator goes out, and the window switches on the rear row work normally.

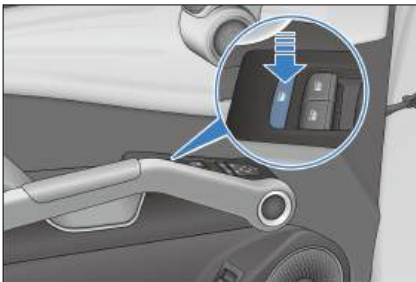

Odometer Switch

- Press the odometer switch to switch between "Total Mileage" - "Mileage 1" - "Mileage 2" - "Total Mileage".

The switching status is displayed accordingly on the instrument cluster.

- Press and hold "Mileage 1" and "Mileage 2" to clear the mileage information.



Driver Assistance Switches

The center console also features a reversing radar switch*, BSA switch*, and AVH switch*.

① Reversing radar switch*

Press this switch to activate parking radar. See **P132** for details.

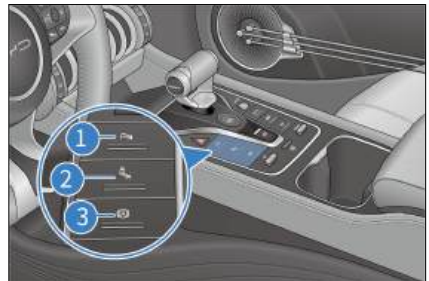

② BSA switch*

Press this switch to activate blind spot assist. (See **P73** for details).

③ AVH switch*



Press this switch to activate automatic vehicle hold. See **P113** for details.

Window Control Switch on Passenger Side

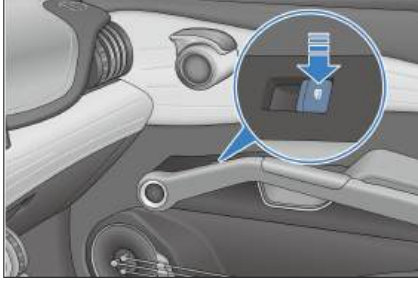
When the ignition is on, the window control switches near passengers can be used to roll the associated windows up or down.



Hazard Warning Light Switch

When the  button is pressed, all turn signals and turn signal indicators on the instrument cluster start flashing. They all stop flashing when the  button is pressed again.



CAUTION

- The hazard warning lights are used to alert drivers and pedestrians of possible risks.

Mode Switches

These switches enable drivers to select from the different regenerative braking, snow, and ECO, SPORT or NORMAL modes.

① Regenerative braking mode button

- The default setting is the standard regenerative braking mode.
- Toggle up the lever ① to increase regenerative braking force.

② Snow mode button

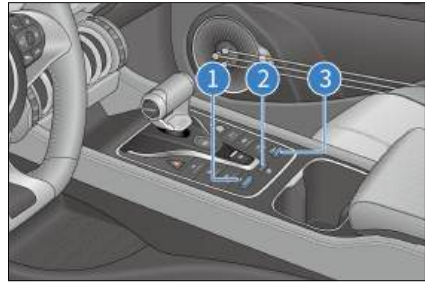

- Press down the snow mode switch ② to put the vehicle in snow mode.
- This mode is recommended on fairly strong surfaces covered in slippery materials such as grass, snow, ice, or gravel.
- Although snow mode optimizes traction, driving performance, and maneuverability, it is recommended to avoid sudden acceleration or high speed.

③ MODE switch

- The default setting is ECO mode.
- Move up the lever ③ to switch the vehicle to the SPORT mode.
- Move down the lever ③ to switch the vehicle to the NORMAL mode.

- Move down the lever ③ repeatedly to cycle through NORMAL → SPORT → ECO → NORMAL mode.
- Move up the lever ③ repeatedly to cycle through NORMAL → ECO → SPORT → NORMAL mode.
- Ecology, Conservation, Optimization (ECO): moderate vehicle power, comfortable driving and riding experience, and better economy.
- Normal (NORMAL): Proper balance between power and energy efficiency.
- Sport (SPORT): The vehicle shows good power performance, but its acceleration performance is reduced at low State of Charge (SOC), or too high or low temperatures.

CAUTION

- Because ESC activation limits the engine torque, momentarily deactivating ESC may help if the vehicle is stuck in deep snow. The ESC system must be restarted after conditions are back to normal.



REMINDER

- When the driver switches modes and releases the accelerator pedal, the vehicle's power output characteristics will change according to the driver's needs. Make sure to drive safely.
- All modes have a power-off memory function. The vehicle will be in the same mode as it was when it was powered off.

PAB Switch*

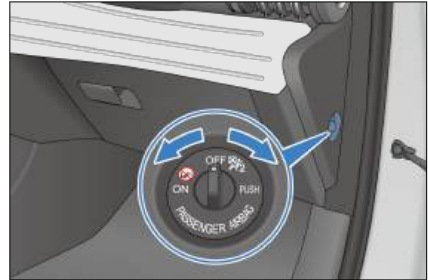
- The front passenger airbag can be deactivated if the vehicle is equipped with a passenger airbag (PAB) switch.
- The switch is located on the passenger side of the dashboard and is accessible when the passenger's door is open.



- Check that the switch is in the required position.
- Enable or disable the front passenger airbag according to the use of the front passenger seat:
 - When the switch is in ON, the passenger airbag is enabled and the touchscreen status bar displays  **PASSENGER AIRBAG ON**. The front passenger airbag deploys in the event of a moderate to severe collision that meets the necessary deployment conditions.
 - When the switch is in OFF, the passenger airbag is disabled and the touchscreen status bar displays  **PASSENGER AIRBAG OFF**. The front passenger airbag does not deploy in the event of moderate to severe collisions that meet the necessary deployment conditions.

WARNING

- Never use a rear-facing child restraint on the front passenger seat if the airbag is activated.
- The passenger airbag must always be activated when a forward-facing occupant rides in the front passenger seat.
- If the requirements above are not followed, there is a high risk of serious passenger injury or even casualty.

CAUTION

- To prevent damage to the airbag system, only operate the passenger airbag switch when the ignition is switched off.
- It is the driver's responsibility to confirm that the passenger airbag switch is in the correct position for the person sitting in the front passenger seat.



- The E-Call system activates automatically in the event of airbag deployment or the detection of a severe collision.
- When triggered, the system automatically makes an emergency call and communicates standard information to a public safety answering point.

CAUTION

- The SOS button will be considered to be short-circuited (button stuck) if you press and hold the SOS button for over 20 seconds. In that case, the E-Call cannot be triggered manually.
- The dialed emergency call cannot be canceled manually. The E-Call system will begin 60-minute callback time after the call is hung up by the public safety answering point or is not answered when it has been dialed 10 consecutive times.

Emergency Call (E-Call)

- E-Call* refers to emergency call. Pressing and holding the SOS button for a maximum of 10 seconds triggers the E-Call system manually, and pressing and holding the button for 10-20 seconds does not.
- To cancel an emergency call made by mistake, press the SOS button a second time within five seconds.

Status	LED Indicator	Beeping
Ignition off or E-Call system failure	Off	\
Power-on self-check mode	Flashing fast - 2 Hz	\

Status	LED Indicator	Beeping
Ignition on and self-check passed	Solid on if self-check is passed	\
E-Call connecting	Flashing - 1 Hz	A beep
E-Call connected	Flashing - 1 Hz	A beep
E-Call ended	Solid on	Two beeps after E-Call ends
Callback time (60 minutes by default)	Flashing extremely slowly - 0.2 Hz	\

Sunroof Switch

Panoramic Sunroof

The sunroof can only be operated when the vehicle is powered on or when the power-off delay has not expired.

Opening the sunroof

- Press and hold the sunroof open button ① to open the sunroof. Release the button midway to stop the sunroof at its current position.
- If the sunroof has been initialized, pressing the sunroof open button ① and release it immediately, the sunroof tilts up for ventilation. Pressing the button again will set the sunroof to open automatically by about 80%. Touching the button once more will open the sunroof completely. If button ① or ② is pressed when the sunroof is opening, the sunroof will stop at its current position.

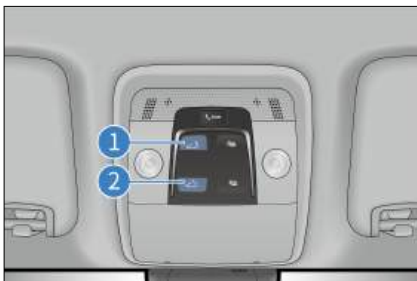

Closing the sunroof

- Press and hold the sunroof close button ② to close the sunroof. Release the button midway to stop the sunroof at its current position.
- If the sunroof has been initialized, releasing the sunroof close button ② immediately after touching it closes the sunroof automatically. For the sunroof to stop at its current position, press the ① or ② button midway.

Opening/Closing Sunshade

Opening the sunshade

- Press and hold the sunshade open button ① to open the sunshade. Release the button midway to stop the sunshade.
- Release the sunshade open button ① immediately after touching it. The sunshade opens automatically. For the sunshade to stop at its current position, touch the ① or ② button midway.



Closing the sunshade

- Press and hold the sunshade close button ② to close the sunshade. Release the button midway to stop the sunshade at its current position.
- If the sunshade has been initialized, releasing the sunshade close button ② immediately after touching it closes the sunshade automatically. For the sunshade to stop at its current position, touch the ① or button ② midway.

CAUTION

- When opening or closing the sunroof sunshade, avoid forceful contact with its curtain to prevent damage.

Sunshade linkage function

- When the sunroof is opened, the sunshade will be opened together with the sunroof.

Sunroof Anti-pinch

If the sunroof or sunshade closing process is obstructed by anything, it will stop and slightly retract.

WARNING

- Keep clear of the sunroof when it is opening or closing, or severe injury may occur.

WARNING

- Passengers must refrain from sticking hands or their heads out through the sunroof. Otherwise, severe injury or even death may occur.

CAUTION

- Trying to open the sunroof in outside temperatures below 0°C or when it is covered in snow or frost may damage the sunroof or its motor.

Initialization

- With the ignition on, the signal remains valid and the sunroof is in the uninitialized state, try the following steps for initialization:
 - Press the close button once to fully close the sunroof/sunshade.
 - If the sunroof/sunshade does not close fully, calibrate manually. Press and hold the sunroof/sunshade close button, and release it when the sunroof/sunshade stops moving. Hold the button again for at least seven seconds, and release it until the sunroof/sunshade is fully closed and a click sound is heard.
 - The sunroof and sunshade are initialized separately.

Interior Light Switch

Front Interior Lights

- Press the interior light buttons to turn on left/right interior lights. Press again to turn them off.

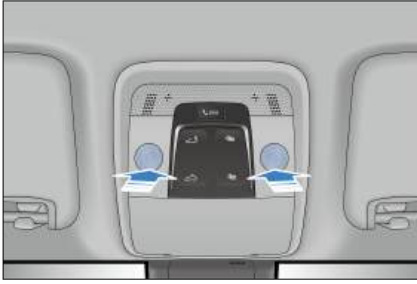

Rear Interior Light Switches*

- With the vehicle in any power mode, press this button to turn on the left/right interior light.
- Press again to turn off the left/right interior light.



Smart Ambient Lights*

When the door is opened, the smart interior ambient lights turn on automatically to create a pleasant environment in the cabin.

- Tap  → **Vehicle Settings** → **Lights** to set:
 - Ambient light color
 - Ambient light brightness
 - Ambient light adjustment area
 - Dynamic ambient light

04

USING AND DRIVING

Charging/Discharging.....	82
Batteries.....	95
Usage Precautions.....	100
Starting and Driving.....	107
Driver Assistance.....	115
Other Main Functions.....	140

Charging/ Discharging

Charging Instructions

- Charging equipment uses high-voltage current. Minors are prohibited to charge the vehicle or touch the charging equipment. Keep them away from the vehicle during charging.
- Charging may affect medical or implanted electronic devices. Consult the device manufacturer before charging.
- Charge the vehicle in a relatively safe environment, and avoid charging in damp areas, or areas with fire or heat sources.
 - Protect the charging equipment against water contact on rainy days.
- Before charging:
 - Ensure that power supply equipment, charging connector, charge port, and charging connection device are free of defects, such as cable wear, rusted ports, cracked casings, or foreign objects in the ports.
 - Do not charge the vehicle when the charging connector's or port's plug, socket, or metal terminals are loose or damaged by rust or corrosion.
 - When the charging connector, port, power plug, or socket is visibly stained or damp, wipe them with a dry and clean cloth to ensure the connection is dry and clean.
- Use a standard-compliant charging equipment.
 - To avoid charging failure or fire, do not modify, disassemble, or repair the charging equipment and related ports. Contact a BYD authorized dealer or service provider for handling if there is a fault.
- Do not use charging equipment that does not meet safety standards or has potential safety hazards. Do not allow children to use the charging equipment and keep animals away from the vehicle while charging.
- Never drop the equipment or move it by pulling it directly by the cable. Take caution when moving and using the equipment.
- Ensure that your hands are properly dry before charging.
- If anything abnormal is found in the vehicle or charging equipment during charging, stop immediately and contact a BYD authorized dealer or service provider.
- Always observe the following charging precautions to prevent damage to the vehicle:
 - Do not shake the charging connector, otherwise the vehicle charge port may be damaged.
 - Whenever possible, do not charge the vehicle in a thunderstorm, or there will be a risk of lightning strikes.
- Do not open the hood for maintenance while charging.
- After charging, do not disconnect the charging equipment with wet hands or while standing on any wet surface.
 - Before driving, ensure that the charging equipment is disconnected from the charge port.

Vehicle compatibility and charging infrastructure

- These signs are located on the vehicle charging socket and charging

infrastructure components (e.g., charging stations and sockets).

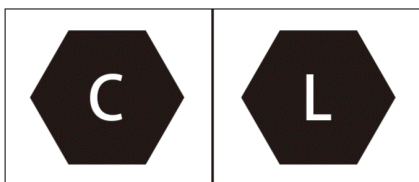

- These signs refer to standardized charging systems in accordance with DIN EN 62196.

Charging Precautions

- When the SOC bar on the instrument cluster turns red, the high-voltage battery is about to be exhausted. Please charge it immediately, otherwise the service life of the high-voltage battery will be reduced.
- Mode 2 charging means charging with an AC charging connector. Use a dedicated AC line and power outlet that meets local standards. The purpose of using a dedicated line is to protect the line from tripping due to line breakage or high-power charging of the high-voltage battery. Using a line other than dedicated lines may affect proper operation of other devices on the line.
- Avoiding damage to the charging equipment (precautions for charging equipment):
 - Prevent the charging equipment from any mechanical impact, such as falling and colliding with other objects.
 - Do not place the charging equipment near heaters or other heat sources.
- Before charging:
 - Make sure that the charging connector and charge port are free of foreign objects, and that the protective cap of the charging connector terminal does not get loose or deformed.
- Hold the charging connector with one hand, align the connector with the charge port and push it in, making sure that they are properly connected.
- When charging is complete:
 - Stop charging first and make sure the charge port is unlocked.
 - Pull out the charging connector.
 - Do not force the charging connector out while the charge port is locked, otherwise the charge port may be damaged.
- The vehicle can be powered on to use A/C while charging. To ensure the charging power, it is recommended to turn off the A/C.
- It is recommended that no one stay in the vehicle during charging.
- It is recommended to park the vehicle in a ventilated area during charging.
- The vehicle system automatically stops charging when the high-voltage battery is fully charged. The charge port is equipped with an electronic lock. Unlock it before unplugging the charging equipment.
- To stop DC charging, turn off the charger before disconnecting the charging connector. In Mode 2 charging, remove the charging connector and then the power plug.
- When charging is complete and the charging connector is unplugged, make sure that the charge port's cap and door are closed, otherwise water or foreign materials may enter the port and affect its normal use.
- Before starting the vehicle, check that the charging equipment is

disconnected. When the charging connector is loosely inserted, you may still be able to power on the vehicle and drive it off. This will damage the charging equipment and the vehicle.

- Battery temperatures that are too low or too high compromise vehicle charging performance.
 - The temperature control system can improve low-temperature charging capacity of the battery. Due to output capacity limitations of charging piles, the charging time is extended, the heating time becomes longer and the power consumption of heating is increased. This is a normal phenomenon.
 - For faster low-temperature DC charging, charging from low SOC is recommended because, due to the low battery temperature, the charging current is small for vehicles with high SOC in low-temperature environments.
 - To improve your experience at low temperatures, it is recommended to charge the vehicle immediately after using it, as the battery is relatively hot and has better charging performance.
- Turning A/C on during low-temperature charging affects the performance of the battery temperature control system and charging.
- It is normal that when the battery temperature control system is working during charging, the charging power displayed on the instrument cluster may fluctuate temporarily.
- Before charging is complete, battery equalization is activated for longer battery life and thus the charging time may be longer.

- The use of A/C may worsen battery temperature control system performance in DC charging at high temperatures, resulting in lower charging performance and longer charging time. To ensure charging efficiency, it is recommended to keep the A/C off during charging.
- When the heating or cooling function is enabled during charging, it is normal that both charging time and power consumption increase slightly.
- To ensure optimum battery temperature, the battery cooling system may continue working after charging is complete.
- During charging, the estimated remaining time to full charge is displayed on the instrument cluster or infotainment touchscreen. It is normal that this charging time may vary slightly across temperatures, SOC, and charging facilities. Before charging is completed, "Calculating..." is displayed on the instrument cluster.
- If you leave the vehicle parked for longer periods of time, it is recommended to charge it every three months in order to prolong its service life, and fully charge it before use again.

REMINDER

- Do not open the charge port door forcibly when it is locked.
- Do not close the charge port door when the port cap is fully open.
- When the vehicle is charged, it is normal that the cooling fan and A/C compressor may operate automatically for the high-voltage battery to cool down.

General Charging Troubleshooting

Fault	Possible Cause	Solution
Charger is connected and charge starts, but battery cannot be charged.	Charging card in arrears or faulty charging pile.	Consult card balance or contact charging station staff.
	The AC charging connector is not properly plugged in.	Ensure the charger switch has come up. Check cable length and connection correctness.
	Low-voltage battery over-discharges.	Connect the vehicle to another 12V low-voltage battery to charge its own low-voltage battery after the vehicle is powered on.
	The local standard socket has no power supply.	Ensure the power supply is under overload protection. Use an outlet that complies with local standards.
	Vehicle or AC charging connector failure	Check for power system fault warning light or charging system fault message on the instrument cluster. If found, stop charging and contact a BYD authorized dealer or service provider.
	High-voltage battery temperature above or below specification	Warm up or cool down the high-voltage battery. Keep the vehicle in an environment with appropriate temperature and charge it when the temperature becomes normal.
Charging stops midway.	The high-voltage battery has been fully charged.	When the high-voltage battery is fully charged, the charging will stop automatically.
	Charging cable is not connected properly.	Verify that the charging connection cable is not loosely connected.
	AC grid outage	Charging will restart automatically a while after AC supply returns to normal. If it doesn't, reinsert the charging connector.
	The high-voltage battery temperature is too high.	Charging stops automatically if the high-voltage battery overheating warning light comes out on the instrument cluster. Charge the vehicle when the battery temperature returns to a normal level.
	Vehicle or charging pile fails.	If there is any fault prompt for the charging pile or the vehicle, it is recommended to contact a BYD authorized dealer or service provider.

Charging

- Before charging:
 - Check the charging device for abnormalities such as cracked housing, worn cable, rusted plug, or foreign materials.
 - Do not charge when the charging connection becomes loose.
 - Make sure the port is clear of fluids or foreign objects, and its metal terminals are not rusty or corroded.
- In any of these cases, do not charge. Otherwise, personal injury may occur due to short circuit or electric shock.

Using Mode 2 Charging Cable

1. Equipment

- Connect the vehicle to a socket that meets local standards to charge the vehicle.
- A household socket meeting local standards must be used in order to avoid line damage or tripping due to high-power charging, which may affect the normal use of other devices.
- This Mode 2 charging cable includes a power plug (complying with local standards), a charging connector, a control box, and a charging cable. The plug is connected to a standard household power socket, and the charging connector to the vehicle's charge port.
- Charging time: Refer to the charging time message on the instrument cluster or infotainment touchscreen.

WARNING

- See **P82** in section "Charging Instructions" for charging safety warnings.
- The highest working temperature allowed for the product is 50°C. Store it in a cool and dry place when it is not in use.
- When charging, do not place the equipment in the trunk, under the front of the vehicle, or near the tires.
- When using the equipment, prevent it from getting rolled over by the vehicle, dropped, or trampled on.
- Never drop the equipment or move it by pulling it directly by the cable. Take caution when moving the equipment.
- It is not recommended to use any additional wire or adapter/connector. If an additional adapter is required, choose a suitable cable diameter ($\geq 1.5 \text{ mm}^2$) and the adapter/connector parameters must meet requirements.
- Never use the charging equipment if the household power strip cable becomes soft, the charging connector cable is worn out, the insulation layer is cracked, or any other damage occurs.
- Never use the equipment when the charging connector, power plug, or power strip is disconnected, broken, or there is any sign of surface damage.
- To prevent failure of the charge port door, do not open and close it repeatedly.

⚠ CAUTION

- Contact a BYD authorized dealer or service provider to select the appropriate power supply according to the charging equipment requirements.
- Charging equipment grounding instructions: The equipment must be properly grounded. In the event of failure or damage to the equipment, the grounding cable provides a minimum impedance to circuit discharge and thereby reducing the risk of electric shock.
- The power plug must match a properly installed and well-grounded power supply outlet.

ℹ REMINDER

- The charging cable must not be placed in a spiral during charging, as this will affect heat dissipation.
- See **P83** for specific charging precautions.

2. Charging

- Power off the vehicle.
- With the doors unlocked, press the charge port door to open.



- Open the charge port cap and the protective cover* of the charging connector. Make sure that no obstacles

exist between the head of the charging connector and the end of the charging socket.

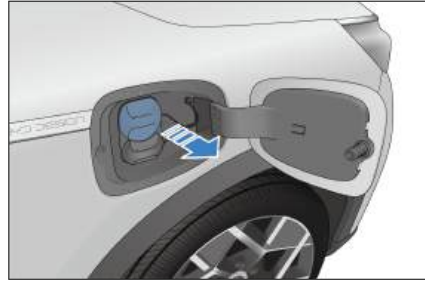

- Connect the power supply terminal:
 - Plug the Mode 2 charging cable into a household socket.
- Connect the vehicle port:
 - Plug the charging connector correctly into the port.
 - After the charging connector is inserted, the charging connection indicator lights up on the instrument cluster or infotainment touchscreen.

⚠ CAUTION

- In the charging process, the instrument cluster displays relevant charging parameters and the charging sign.
- At this time, you can go to  → **Energy** → **Charging Settings** to set smart charging.
- During charging, the estimated remaining time to full charge is displayed on the instrument cluster. It is normal that this charging time may vary slightly across temperatures, SOC, and charging facilities.

CAUTION

- Smart charging cannot be used when the remaining battery is too low.

3. Stopping charging

- End the charging:
 - The charging automatically ends when the vehicle is fully charged.
 - To end the charging early, proceed to the next step.
- Unplug the charging connector:
 - Press the unlock button on the smart key or press the door handle microswitch while carrying the smart key and pull out the charging connector.

REMINDER

- To unlock the vehicle, press the unlock button on the key (when charging the vehicle with ignition switched off) or press the microswitch on the door handle (when the key is nearby).
- To pull out charging connector and end charging, unlock the vehicle to deactivate the anti-theft lock before pulling out the charging connector. The connector has to be pulled out within 30 seconds, or the port will relock.
- The anti-theft lock can be set in  → **Energy** → **Charging Settings**. See *P93* for details.
- If the charging connector cannot be removed after unlocking, try a few more unlocking attempts. If that does not work, try emergency unlocking. For the operating

REMINDER

procedure, see *P93* in "Charging Port Immobilizer System".

- Disconnect the power plug.
- Close the charge port cap and the port door.
- Store the charging equipment properly.

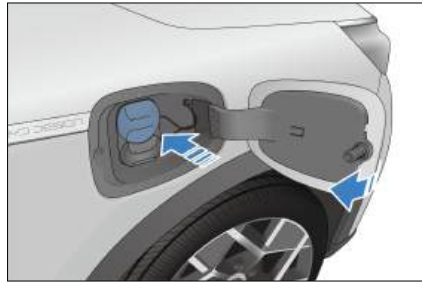

REMINDER

- Do not close the charge port door when the port cap is fully open.

Using AC Charging Piles *

1. Equipment

- Single-phase AC charging box*
 - Use a standard-compliant household charging box. For how to use the charging equipment, refer to its user manual and follow the operating steps.
 - The single-phase AC charging box consists of a charging box, a charging connector, and a connecting cable. For information on circuit breaker and emergency stop switch, see the charging box user manual.
- Single-phase AC charging pile

- Charge the vehicle using an AC charging pile in a public place.
- Charging time: Refer to the charging time message on the instrument cluster or infotainment touchscreen.

2. Charging

- Unlock the vehicle and open the charge port door:
 - Unlock the charge port door, then open the port door and cap, see **P86** for details.
- Connect the vehicle port:
 - Plug the charging connector into the port and make sure it is tight.
- Charging settings:
 - For AC charging pile/box subject to authentication, swipe the card or scan the QR code. For details, see the user manual for charging pile/box.
- The charging connection indicator  lights up on the instrument cluster.
- In the charging process, the instrument cluster displays relevant charging parameters and the charging sign.
 - At this time, you can schedule smart charging on the infotainment system.

3. Stopping charging

- End the charging:
 - Charging stops automatically when it is interrupted by the user, or when the battery is fully charged.
- Unplug the charging connector:
 - Unplug the charging connector, see **P86** for details:
- Close the AC charge port door (see Mode 2 charging **P86** for details).
- Store the equipment properly.

- If using an AC charging pile/box, place the charging connector in its designated location in the charging pile/box.

Using DC Chargers

1. Equipment

- Use the DC battery charger in public places to charge the vehicle. Generally, it is installed in a specific charging station.
- Equipment specifications: Please check the instructions for the charger.
- Charging time: Refer to the charging time message on the instrument cluster or infotainment touchscreen.

2. Charging

DC charging is achieved by connecting the vehicle to a DC charger via its connector.

- Unlock the charge port door, then open the port door and cap.
- Connect the vehicle port:
 - Plug the connector into the port, making sure it is tight.
- Operate the charging equipment to start charging.

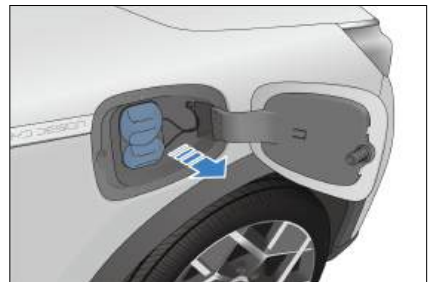

- The charging connection indicator  lights up on the instrument cluster.
- In the charging process, the instrument cluster or infotainment touchscreen

displays relevant charging parameters and the charging sign.

3. Stopping charging

- End the charging:
 - Charging ends automatically when early stop time is due or the charging is complete. You can end charging through charging app or swiping card.
 - Double-pressing the unlock button of driver's door or on the smart key within three seconds to stop charging.
- When the DC charging pile charging is complete, organize the charging equipment and store the charging connector in its designated position properly.
- Reinsert the DC charge cap and close the port door.

WARNING

- See **P82** for charging safety warnings.



CAUTION

- If the charging connector cannot be removed after charging, try a few more unlocking attempts. If that does not work, try emergency unlocking. For the operating procedure, see **P93** in "Charging Port Immobilizer System".
- To unlock the charge port after DC charging, press the unlock button twice within three seconds for the operation to be successful.
- See **P83** for charging precautions.

REMINDER

- When the port cap is fully open, do not close the charge port door.

Scheduled Charging

- The charging mode can be set on the infotainment touchscreen or by calling the BYD Assistant. To access the setting:
 - Go to infotainment touchscreen →  → **Energy** → **Smart Charging** → **Scheduled charging**.
 - To enter the setting page, say "Hi BYD, start scheduled charging", "Hi BYD, I want to make scheduled charging" or "Hi BYD, please help me start scheduled charging".
- To exit the Scheduled Charging screen, tap  or  .
 - To exit the page, say "Hi BYD, end scheduled charging" or "Hi BYD, exit scheduled charging".

Setting screen

- ① Scheduled charging switch
- ② Charging time
- ③ Repeat cycle
- ④ Settings



- The factory default setting is to charge the vehicle immediately. That is, scheduled charging is disabled.

- To schedule a charging, toggle the scheduled charging ON ①, set the charging start time ② and repeat cycle ③, then save the settings.
- After the schedule is set up successfully, if you connect the charging connector or press the power button to power off the vehicle during the charge waiting period, you will be reminded through the infotainment touchscreen that scheduled charging has been set. Switch to instant charging if needed.
- You can tap the scheduled charging setting icon ④ to turn off the charging connector connected alert and power-off alert in the **Scheduled Charging Alert**.



CAUTION

- The scheduled charging function is developed for BYD's slow AC charging equipment only. Please disable this function when using non-BYD-certified slow AC charging equipment. Otherwise, scheduled or immediate charging may fail due to no response from the equipment, resulting in low SOC or low voltage of the high-voltage battery.



REMINDER

- The instant charging option on the reminder screen is valid for the current schedule only. To cancel all schedules, toggle scheduled charging off on the corresponding setting screen.
- In the event of low battery, the vehicle is charged to the minimum level before scheduled charging begins. In this process, the infotainment system still gives reminder messages for



REMINDER

- power-off and charging connector connection, and a related message is displayed at the lower part of the instrument cluster.
- The vehicle's power will increase while waiting for the scheduled charging. It is normal for long waiting to result in a reduction of the vehicle's SOC and driving range.
- The schedule setting is invalid for DC charging. Charging begins immediately after a DC charging connector* is connected.

Intelligent Charging

- When the manager detects that the low voltage battery capacity is low, the low voltage battery can be charged by the high-voltage battery, so it is normal that the SOC and driving range displayed decrease when the vehicle is powered on after an idle period.



REMINDER

- When the vehicle lies idle for long periods, it is normal that intelligent charging takes place.
- Power for intelligent charging comes from the high-voltage battery pack, so it is normal that an SOC decrease is noticed when the vehicle is powered on.

Discharging Device

- This vehicle features a Vehicle to Load(VTOL) equipment:

WARNING

- Do not touch any metal terminal of the discharging socket or the vehicle charge port during discharging.
- Stop discharging immediately if there are any abnormalities such as peculiar smell and smoke.
- See "Charging Instructions" for discharging safety warnings.
- Store the product in a cool and dry place when it is not in use.
- When discharging, do not place the equipment in the trunk, under the front of the vehicle, or near the tires to prevent it from falling and being rolled over by the vehicle and trampled on.
- Never use the discharging equipment if the power strip cable becomes soft, the discharging connector cable is worn out, the insulation layer is cracked, or any other damage occurs.
- Never use the equipment when the discharging connector or power strip is disconnected or broken, or when there is any sign of surface damage.

CAUTION

- For precautions concerning use of the discharge connection device, please refer to the precautions for charging equipment in **P83**.
- Before discharging, please confirm the vehicle SOC and estimate the remaining driving range.

REMINDER

- The V2L function is recommended only when SOC is high.
- The V2L function is restricted when the vehicle SOC is low.

External Discharging

Starting discharging

- Before discharging, disarm the anti-theft alarm system.
- Unlock the charge port door switch, then open the port door and cap.
- Check before discharging:
 - Ensure that the battery capacity of the vehicle to be discharged is not below 15%.
 - Ensure the V2L connection device casing is not cracked, and its plug is free from rust or obstructions.
 - Ensure that there is no water or foreign material inside the charge port and that metal terminals are not damaged and free from rust or corrosion.
 - Do not discharge if any of the above conditions is found; otherwise, short circuit or electric shock so caused could lead to personal injury.
- Connect the discharge connection device:
 - Connect the V2L discharge device to the charge port. The power strip indicator lights up when the strip is powered and ready for use.
- Discharging starts:
 - After the connection is made, discharge begins and respective information is displayed on the instrument cluster.

Stopping discharging

- Stop discharging:
 - Disconnect the load.
- Disconnect the discharge connection device:
 - Unplug the discharging device.
 - Close the charge port cap and the port door (see Mode 2 charging **P86** for details).
- Organizing the equipment:
 - Store the equipment properly when discharging is complete.

Charging Port Immobilizer System

- In order to prevent the charging connector from being stolen, the vehicle charge port is anti-theft during charging and discharging. The charging port immobilizer system is disabled by default. To enable it, go to the infotainment touchscreen →  → **Energy** → **Charging Settings**.

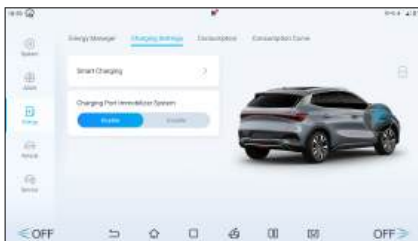

- When the function is enabled, unlock the vehicle and unplug the charging connector during charging in the following ways:
 - When it is on OFF status, press the unlock button on the smart key to unlock.
 - Press the microswitch next to the exterior handle of the driver's side

door to unlock (with the smart key nearby).

- Press the central unlock button under the window on the driver's door to unlock.

CAUTION

- After unlocking the charging connector, it can be pulled out within 30 seconds. After 30 seconds, it will lock again.

Emergency Unlocking of Charge Port

- When charging connector cannot be unplugged due to failure of the anti-theft lock, unlock the charge port manually.
- Open the hood. A lock latch can be found inside. Pull the latch to unlock the charging connector.

Configuration 1

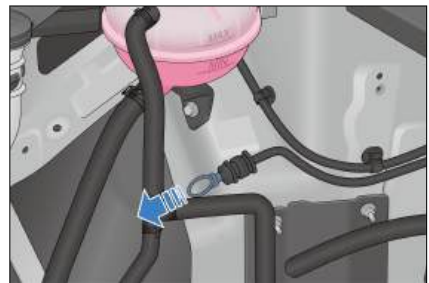

Configuration 2

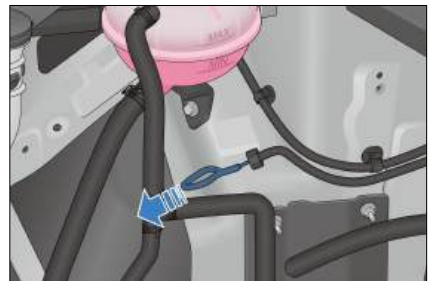

Range Mode*

- The range display mode can be set to improve driving experience. The default setting is standard mode.
- The corresponding settings are accessible on the infotainment touchscreen →  → **Energy** → **Energy Manager** → **Range Mode**.
 - Standard mode: displays the driving range based on the result of comprehensive working condition test.
 - Dynamic mode: displays the estimated driving range based on the available battery power and current average energy consumption.
- The set driving range display mode is memorized by the system.
 - When the vehicle is powered off and then on, the display mode set last time will be maintained.

REMINDER

- When the dynamic driving range display mode is set:
 - The driving range that is displayed after a full charge may vary, depending on calculations of the energy consumed the last time the vehicle is used.
 - The driving range actually displayed will be adjusted based on the state of the vehicle's air conditioner, the driving mode (ECO, NORMAL, SPORT, etc.) selected, and the driver's driving habits, so as to match the vehicle's actual remaining driving range.

Regenerative Braking Settings

- Regenerative braking: In this process, the motor will generate reverse torque when the vehicle is decelerating, and the generated energy will be recovered and reused to improve the energy utilization rate of the vehicle.
- Braking regeneration:
 - When the vehicle is running in Drive, if you completely release the accelerator pedal and depress the brake pedal, and the vehicle is in a stable state, priority is given to responding to motor regeneration for deceleration during braking and deceleration. When the motor capacity is insufficient, the hydraulic brake will actively intervene to maintain the deceleration demand of the vehicle, and the generated energy will be recovered to improve the vehicle economy.
- Sliding regeneration:
 - When the vehicle is running in Drive, if you release the accelerator pedal at a certain depth, the motor will output reverse torque to decelerate the vehicle, and the generated energy will be recovered to improve the vehicle economy.
 - During the driving, energy is recovered through regenerative brakes when the vehicle decelerates. For higher efficiency, do not accelerate or decelerate the vehicle unnecessarily.
 - The energy regeneration intensity can be set with the regenerative mode button or on the infotainment touchscreen.
 - Standard: When the accelerator pedal is released, the motor controller recovers energy in the

standard level, and the vehicle deceleration is in the standard level.

- High: When the accelerator pedal is released, the motor controller recovers more energy, and the vehicle deceleration is high.
- The corresponding settings are accessible in the infotainment touchscreen →  → **Energy** → **Energy Manager** → **Regenerative Braking**.
- You can select the regeneration intensity based on the deceleration sense when releasing the accelerator pedal. Different deceleration senses deliver different driving experiences.
- The set energy regeneration intensity will be memorized. When the vehicle is powered off and then on, the regenerative braking mode set last time will be maintained.
- The power of the whole vehicle is weaker at low battery level than that at high battery level.

REMINDER

- Do not set the regeneration intensity when driving at high speed, as you may be distracted, resulting in accidents.

Batteries

High-Voltage Battery

- The vehicle is powered by a high-voltage battery that can be charged and discharged repeatedly. The high-voltage battery is charged by an external power source or through energy recovery when the vehicle brakes or coasts.

- The high-voltage battery is located at the vehicle's chassis, so be careful to avoid bumping when driving on bumpy or uneven roads.

Battery Properties

- The charging and discharging power of the high-voltage battery is related to the state of the battery pack, which is mainly affected by its SOC and the temperature of the battery cell.
- It is normal that vehicle performance is affected by battery electrochemical properties and self-protection and varies to some extent in the following conditions:
 - When SOC is high, the regenerative braking performance may decline.
 - The vehicle switches to trickle charging mode at high SOC. If the charging time is prolonged, the estimated remaining charging time displayed on the instrument cluster may not be accurate.
 - When SOC is low, the acceleration performance may decline.
 - When the high-voltage battery is low, V2L/V2V* cannot be used as normal. Charge the battery promptly.
 - At high or low temperatures, it is normal that the charging and discharging capabilities of the high-voltage battery decline, and the charging time is prolonged. For fast charging, high-power charging equipment is recommended. Power performance may also decline under extreme temperatures.
 - When charging at low temperatures, the temperature control system can significantly improve the battery's charging capability. For details regarding low-temperature charging, see **P83**.

- When the vehicle is used at low temperatures, the battery's temperature control system will start heating the battery as appropriate to ensure the driving power and discharging performance and improve your driving experience. When the vehicle is driven over short distances, heating may be ineffective, which increases power consumption and decreases driving range.
- When the high-voltage battery is normal, the driving range of the vehicle varies with the following factors:
 - Driving habit: For example, the range in frequent acceleration or deceleration is shorter than that at constant speeds, and the range is shorter when driving at high speeds than when at low speeds.
 - Road conditions: For example, the range driven in rough conditions or on long slopes is shorter than that in normal conditions and on even roads.
 - Temperature: The driving range at low temperatures is shorter than that at ambient temperatures.
 - Use of electric equipment: For example, the range driven with A/C on is shorter than that with A/C off.
 - Usable capacity of the high-voltage battery is lower in cold weather and reduces as the temperature decreases. If the vehicle with high battery level is charged at low temperatures, the SOC may quickly jump to 100%.
- The available battery capacity decreases as the vehicle is used over time.

Battery Usage Tips

- It is recommended to use the vehicle at temperatures between -10°C to 40°C. When SOC is low, timely charge the vehicle to ensure enough driving range and good acceleration performance.
- To ensure long-term performance, do not expose the vehicle to extreme temperatures (above 60°C or below 30°C) for over 24 hours.
- In low ambient temperatures, if the vehicle must be stored for a long time, it can be placed in an underground garage or other warmer area to reduce loss of battery heat, maintaining vehicle performance.
- Frequent and sudden acceleration or deceleration should be avoided. Drive the vehicle on flat and dry roads. When necessary, turn off high-power equipment such as A/C or adjust the A/C temperature to reduce power consumption of such devices and increase the driving range.
- When the vehicle is used for the first time or after a long idle period, the SOC displayed on the instrument cluster may not be correct. It is recommended to fully charge the vehicle first.
- For optimal battery performance, it is recommended to fully charge the vehicle at a regular basis (at least once a week), and fully charge it from low battery (SOC <10%) once every three to six months.
- Under extreme working conditions (such as frequent sudden acceleration/ deceleration) that cause battery overheating, if the temperature of high-voltage battery is excessively high, it is normal for discharging capability to decrease gradually. If the battery temperature keeps rising, the fault warning light lights up on

the instrument cluster. In that case, it is recommended to contact a BYD authorized dealer or service provider.

- When the battery SOC increases or decreases abnormally, it is recommended to contact a BYD authorized dealer or service provider for inspection.

WARNING

In the event of an emergency or accident, be aware of the following warnings:

- To avoid personal injury, do not touch the high-voltage battery directly.
- Please contact a BYD authorized dealer or service provider as soon as possible.
- If the high-voltage battery is damaged and leaking fluid, avoid any contact with the fluid. If it comes into contact with skin or eyes, rinse immediately with plenty of water, and seek immediate medical attention.
- If the vehicle catches fire, use dedicated fire extinguishers instead of water-based fire extinguishers.

CAUTION

- To ensure safety of the high-voltage battery, stop the vehicle away from flammable and explosive materials, ignition sources and various hazardous chemicals.
- The available battery capacity decreases as the vehicle is used over time.
- Prolonged exposure to heat sources and direct sunlight reduce

CAUTION

the service life of the high-voltage battery.

- When the vehicle is not to be operated for an extended period (over seven days), it is recommended that the battery SOC should be kept at 40%-60% to prolong its service life. When the vehicle is not to be operated for over three months, the high-voltage battery must be fully charged and then discharged to 40%-60% every three months. Otherwise, over-discharge may lead to battery performance degradation or even damage. Any vehicle fault or damage so caused will not be warranted.
- If there is a collision with the high-voltage battery, contact a BYD authorized dealer or service provider immediately for maintenance.
- Do not add battery coolant by users themselves. If needed, please contact a BYD authorized dealer or service provider.

High-Voltage Battery Recycling

How to scrap an NEV:

1. Take the vehicle to the BYD recycling service provider that will assess the residual value of the high-voltage battery.
2. Take the assessed vehicle to the recycling organization to disassemble the high-voltage battery.
3. Take the battery to the recycling service provider which will buy back the battery.

 **WARNING**

- New energy car owners have the responsibility and obligation to hand over waste high-voltage batteries to the recycling service outlet. Anyone who hands over a used high-voltage battery to any other organization or individual, or removes/disassembles a high-voltage battery without authorization, shall be liable for any environmental pollution or safety incident so caused.

Low-Voltage Battery*

The 2 poles of the low-voltage battery are positive terminal ("+") and negative terminal ("-").

- To prevent the SOC of the low-voltage battery becoming too low, the intelligent charging function is triggered automatically when conditions are met (ignition off, high-voltage battery discharging allowed, and low-voltage battery level below the design value).
- If the battery voltage is too low, it may not be able to power on the vehicle. In that case, contact the BYD authorized dealer or service provider promptly.
- Check the conditions of the low-voltage battery once a month, including corrosion of its poles. If the poles are corroded, disconnect the negative terminal and apply soda solution (adequate to cover the poles) on them. Then the water bubbles and turns brown. When the bubbles dissipate, clean the poles with pure water, wipe them dry, and apply some grease to prevent further corrosion.
- If the connector becomes loose, tighten the clamp nut, but do not overtighten it. Tighten the

pressing tool until it securely fixes the low-voltage battery in place. Overtightening will damage the battery box.

 **WARNING**

- The low-voltage battery contains a corrosive solution. To prevent damage to the battery or injury, do not disassemble or repair the battery.
- Do not disassemble or dismantle the low-voltage battery. Any organization or individual to do so shall bear the responsibility for environmental pollution or accidents.
- Since the low-voltage battery may produce combustible and explosive hydrogen gas, use tools in such a manner that the battery would not produce sparks. Do not smoke or use open flames near the battery.
- Avoid electrolyte contact with eyes, skin or clothing. In case that happens, use baking soda water to clean the skin, and plenty of water to rinse the eyes, and immediately seek medical attention.
- In case of mouth contact with the electrolyte, seek medical attention immediately.
- Keep children away from the low-voltage battery.

 **CAUTION**

- When checking the low-voltage battery, remove the ground cable from the negative terminal (-) first, and reconnect it last.

CAUTION

- When cleaning the low-voltage battery, make sure to avoid any fluid getting inside.

REMINDER

- It is normal that intelligent charging with the ignition off produces a noise similar to when the ignition is switched on.
- Do not carry out maintenance work during intelligent charging.
- When leaving the vehicle, make sure the doors are closed and all electrical devices have been turned off.
- If the vehicle needs to be parked for a long time, please disconnect the negative terminal wire.

Waking up the Vehicle from Low SOC

Wake-up by jump starting*:

If the vehicle cannot be waked up by using the microswitch, use a 12V power supply and two specially designed cables to jump start the vehicle.

- Positive terminal for jump starting: inside the under-hood power distribution box (PDB)



- Negative terminal for jump starting: Unpainted metal on the motor assembly such as bolts as shown.

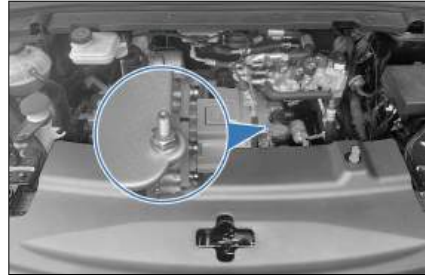

WARNING

- Never jump start another vehicle. This may damage the low-voltage battery.
- If the low-voltage battery SOC is too low or the battery fails, jump starting may be required. Please carefully read and strictly follow the jump starting instructions in this manual.
- The low-voltage battery contains an intelligent control module. To prevent battery damage, do not disassemble or damage this battery, except in an emergency.
- Disconnect the negative terminal of the low-voltage battery before performing parts replacement and vehicle repairs.
- Do not clean the low-voltage battery with water, but wipe it with a cloth instead.

CAUTION

- It is recommended that the jump starting be done under the guidance of professionals, as the space for operating the under-



CAUTION

hood PDB is limited and circuit-based risks are present.

- Do not maintain a high or low speed for too long.
- Avoid emergency braking within the first 300 km.

Usage Precautions

Break-in Period

- If the powertrain is hard to start or frequently stops turning, inspect the vehicle immediately.
- If the powertrain makes any abnormal sounds, stop the vehicle for inspection.
- If the powertrain has severe coolant and oil leakage, stop the vehicle for inspection.
- The powertrain needs break-in, which is recommended to be done within the first 2,000 km in economic mode. Drive steadily and avoid high speed. The following practices effectively prolong vehicle service life:
 - Avoid flooring the accelerator pedal when starting and driving the vehicle.

Trailer Towing

- The vehicle can tow a trailer only when equipped with towing function.
- Do not make non-approved modifications. Contact a BYD authorized dealer or service provider to install the towing kit and related software updates. BYD does not assume any responsibility for injuries or damage caused by non-approved modifications.
- The towing capacity depends on various factors such as vehicle specifications, loads, road conditions, and trailer specifications. The total towing weight must not exceed the limits below:

Item	Parameter	Comment
Maximum towing capacity	750kg	Maximum total towing capacity allowed
Maximum vertical load	75kg	Maximum vertical load allowed on ball joint

1. Maximum allowed towing capacity is total trailer weight, which includes all cargos and additional equipment.

2. Maximum vertical load refers to the downward pressure exerted by the weight of the trailer on the trailer hitch when the vehicle and the trailer are stationary.

- To tow a trailer, adjust the tire pressure to accommodate additional loads. Keep front tires inflated to 250 kPa and rear tires to 270 kPa.
- Observe applicable local laws and regulations regarding towing. For driving safety, avoid speeding and overloading.

- For towing, the technically permissible maximum mass on the rear axle may be exceeded by no more than 15% and the technically permissible laden mass of the vehicle may be exceeded by no more than 75 kg. In these instances, the vehicle speed must not exceed 100 km/h and the rear tire pressure must be at least 20 kPa above the tire pressure recommended for normal use.
- Towing other vehicles will have an adverse impact on the vehicle, including maneuverability, performance, braking, endurance, economic driving or power consumption.
- BYD does not assume any responsibility for damage or injuries resulting from towing a trailer, or from failure to comply with the proper guidelines. Damage caused by towing a trailer is not covered by the warranty.
- For detailed towing instructions, contact a BYD authorized dealer or service provider.

Driving Safety Precautions

No Drunk Driving

Even a small amount of alcohol can reduce a driver's ability to respond to traffic condition changes. The higher the level of alcohol, the less responsive the driver will be. Therefore, never drive while under the influence.

No Speeding

Speeding is a major cause of fatal accidents. Faster speeds generally entail higher risk. Therefore, maintain a speed safe for the road traffic conditions.

Keeping the Vehicle Safe for Driving

Tire bursts and mechanical faults are extremely dangerous. To reduce the possibility of such faults, frequently check the vehicle's condition, and regularly complete the specified inspections.

CAUTION

- Any driver must possess a driver's license before driving a vehicle.
- Do not drive when fatigued.
- Always follow the traffic regulations when driving a vehicle.
- When driving, drivers must stay focused and not carry out any unrelated activity, such as answering calls or adjusting buttons.

Vehicle Use Suggestions

Suggestions for prolong the battery usage:

- When the vehicle is not to be operated for an extended period (over seven days), it is recommended that the battery SOC should be kept at 40%-60%, or it will reduce high-voltage battery service life.
- When the vehicle is not to be operated for over three months, the high-voltage battery must be fully charged and then discharged to 40%-60%. Otherwise, over-discharge may lead to battery performance degradation or even damage. Any vehicle fault or damage so caused will not be warranted.
- During operation of the vehicle, if the instrument cluster displays the pure electric driving mileage as 0, it indicates the battery SOC is low. In this case, charge the high-voltage battery

in time and avoid operating the vehicle with low SOC for a long time.

- For optimal battery performance, use a charging connector to fully charge the battery regularly, and the recommended frequency is once a week at least.
- To maintain long-term performance, avoid continuously exposing the vehicle to an environment with a temperature above 60°C or below -30°C for over 24 hours.
- If the tray dented inward or there is scarification under the battery package tray, it is suggested to check at a BYD authorized dealer or service provider.
- During operation of the vehicle, avoid repeated rapid acceleration or deceleration whenever possible.
- During operation of the vehicle, avoid operating the vehicle continuously for a long time whenever possible; otherwise, the excessively high battery temperature will affect vehicle performance.
- If the instrument cluster malfunctions when driving, it is recommended to contact a BYD authorized dealer or service provider for inspection as soon as possible.
- When the high-voltage battery temperature is high, the vehicle performance will be limited to some extent. In this case, stop the vehicle and wait until the temperature drops before operating.

REMINDER

- If the meter drops to 0, the battery must be recharged. If it is not recharged within seven days, the battery may suffer permanent damage. Such damage is not covered by BYD warranty terms.

REMINDER

- Driving range depends on many factors, such as the vehicle's available power, vehicle age (current battery life), weather, temperature, road conditions and driving habits. Compared with under normal temperatures, the pure-electric driving range is somewhat reduced and power performance will also be affected in low or high temperature environments.

Saving Energy and Extending Vehicle Service Life

- Saving energy is simple and easy, and it helps prolong the vehicle's service life.
- Here are some tips for saving energy and repair cost:

1. Regenerative braking setting:

- The vehicle is provided with an energy regeneration function. To set the energy regeneration intensity, operate the regenerative braking mode button or go to the infotainment touchscreen. In high energy recovery mode, more energy is recovered during vehicle braking and coasting. Please set to suit to your driving habits.

2. Maintaining constant speed:

- Constant speeds save energy. Sudden acceleration, sharp turns and emergency braking increase consumption.
- Speeds should be kept constant according to traffic conditions. Additional energy is consumed each time the accelerator is pushed.

- Acceleration should be gradual. Avoid sudden startup, acceleration, or deceleration.
- Prevent emergency braking, and subsequent brake wear, by keeping an appropriate distance from vehicles ahead, and paying attention to traffic lights.
- Congested roads increase energy consumption.
- Keep moderate speeds in motorways. The higher the speed, the higher the consumption. Maintaining vehicle speed within the economical speed range can save power.

3. Reducing load:

- Consumption is higher when air conditioning is used. Turn off the A/C to reduce power consumption. When outside temperatures are moderate, use fresh air mode.
- Do not overload the vehicle unnecessarily. Excessive weights will add the load of vehicle, increasing energy consumption.

4. Other tips:

- Make sure tire pressure is correct. Low tire pressure increases energy consumption and wear.
- Keep front wheels properly aligned, avoid driving into curbstones, and drive slowly in rough terrain. Misalignment of the front wheels not only increases tire wear, but also increases load on the powertrain and power consumption.
- Keep the bottom of the vehicle clean and mud free. This reduces vehicle weight and prevents corrosion.

REMINDER

- Do not coast in neutral gear.

Carrying Luggage

- This vehicle has multiple storage spaces that allow you to conveniently keep items. Overloading or improper accommodation may affect maneuverability, stability and normal operation of the vehicle, and reduce its safety.
- The glove box, storage boxes on interior trim panels and seatback pockets are designed for small and light objects, while the trunk for large and heavy objects.
- Long items can be loaded by folding the rear seat backrests. Overloading or improper accommodation may affect maneuverability, stability and normal operation of the vehicle, and reduce its safety.
- Make sure the vehicle's total load (vehicle + passengers + luggage) remains within the specified maximum weight.

WARNING

- Overloading and improper accommodation may affect stability and vehicle control, which may lead to accidents.
- Observe the maximum weight limit and other loading guidelines in this manual.
- Do not carry highly magnetic items, as they might interfere in the vehicle's operating functions.

Carrying Items in the Passenger Area

- All items that could be thrown inwards and thus injure occupants in case of a collision must be properly placed and secured.

- Do not place any objects on the inner side of rear windshield. Otherwise, these objects will block the driver's line of sight and will be thrown here and there inside the vehicle in case of collision.
- Ensure that items placed on the floor behind the front seat do not roll under the seat, so as to avoid affecting the driver's ability to control the pedals or normal seat adjustment. Do not stack items to a height taller than the front seats' seatbacks.
- Make sure the glove box is always closed while driving. If the glove box is open, the occupant's knees may be injured in case of a collision or an emergency stop.

REMINDER

- Do not pile up toys in the vehicle, as this may affect driving safety and present a hazard to the children, especially in case of emergency braking or collision.

Loading the Trunk

- Place luggage evenly in the trunk. Put heavier items at the bottom and as far in as possible.
- Secure items with ropes or straps so that they will not move while driving. Do not stack items to a height taller than seatbacks.
- For trunk strapping or fastening supplies, contact a BYD authorized dealer or service provider.

Roof Rack

- Storing luggage on the roof rack will increase overall energy consumption and change the way the vehicle drives and handles.

- Do not open the sunroof with luggage on the roof rack, or you may risk damaging the sunroof and other components with the beam or the luggage.
- When installing the roof rack, please read and follow the manufacturer's instructions.
- Try to load the roof rack evenly and keep the center of gravity low. Loads on the roof rack elevate the overall center of gravity, which might alter your driving experience.
- When driving a heavily loaded vehicle, take extra precautions, drive slowly, and increase your following distance.
- The maximum recommended load evenly distributed over the beam is: 50 kg.

CAUTION

- Luggage must not be put on the roof metal sheet directly. The roof metal sheet is not designed for loading.
- Use the roof rack properly and fasten the luggage on the beam.
- Make sure the luggage is securely fastened on the roof rack before driving and during parking.

Wading into Water

- Check water depth - it must not exceed the vehicle's lower edge before driving into flooded areas.
- If crossing a flooded area is necessary, turn off the air conditioner and keep acceleration steady to slowly cross over.



- Never stop, back up, or turn off the vehicle in flooded areas.
- After crossing over, press the brake pedal several times to dry out the disks and recover brake performance.
- Be careful when driving through deep water, as brakes may get wet.

WARNING

- The presence of water, mud, or silt in the braking system may delay brake response and extend braking distance.
- Drive carefully and avoid emergency braking after crossing flooded areas.
- The motor will be seriously damaged if it is submerged when crossing a flooded area. Such damage is not covered by the vehicle's warranty
- Other systems like transmission, driving and electrical systems may also be seriously damaged upon submersion. Such damage is not covered by the vehicle's warranty either.

Influence of water ingress in high-voltage components:

- Water getting into high-voltage components, which are electronic devices, may not be fully dried out by any means.

- Water ingress seriously compromises insulation of high-voltage components, and conductive substances in water may lead to short circuit of high-voltage components or such risk in the entire high-voltage system. This significantly affects the safety and service performance of the vehicle.
- The reduced ingress protection rating and voltage withstanding performance due to water in high-voltage components pose a high safety risk.
- Be sure to find a sheltered place when charging the vehicle on rainy days. If the vehicle is immersed in water or wades through water over the doorsill, which may cause water ingress in high-voltage components, promptly contact a BYD authorized dealer or service provider for testing and troubleshooting. Do not drive on roads where the depth of accumulated water exceeds half of the tires.

Fire Prevention

To prevent vehicle fires in a timely and effective manner, pay attention to the following during use of the vehicle:

- No flammable or explosive items are allowed in the vehicle.
 - Temperatures may reach 60-70°C in a vehicle exposed to direct sunlight in summer. Therefore, flammable and explosive items, such as lighters, cleaning agents and perfumes, stored in the vehicle can cause a fire or even explosion easily.
- Make sure cigarettes are thoroughly put out.
 - Smoking is harmful to your health and may cause a fire. Cigarettes that

not thoroughly put out may cause a fire.

- It is recommended to go to a BYD authorized dealer or service provider for regular vehicle checks.
 - Check vehicle wiring, connections, wiring harnesses, insulation, and fixed position regularly. Deal with identified problems promptly.
- Do not refit vehicle wiring or add any unauthorized electrical appliance.
 - The addition of extra electrical appliances, such as high-power audio systems, and light fixtures, may overload and overheat the wiring harness and increase the risk of fire.
 - Improper refitting of electrical appliances or wiring may cause a fire due to contact resistance and abnormal heating. Other replacement wires or fuses in excess of relevant electrical rating are strictly prohibited.
- Select a proper parking location.
 - When parking the vehicle, try to avoid sun exposure.
- Keep a lightweight fire extinguisher in the vehicle and know how to use it.
 - In order to ensure vehicle safety, a fire extinguisher should be equipped in the vehicle, and be checked and replaced regularly. Also, you should familiarize yourself with use of the fire extinguisher and be prepared for any accidents.
- Disconnect the negative cable of the low-voltage battery when the vehicle is being serviced or repaired.
- In the event of a fire in the vehicle, take effective measures in a timely and calm manner to minimize any losses:

- Fires typically show initial warning signs, such as abnormal noises and odors in the vehicle body. When abnormal conditions are found, turn off and stop the vehicle immediately. It is best to park the vehicle in a windproof place, and then put out the fire using the fire extinguisher in the vehicle.
- Call the fire alarm in time, and also dial the insurance company's reporting number and ask the company to come to the fire site for handling.
- Look for the ignition point. If the cabin is smoking, do not open the hood immediately. (Doing so will let a large amount of air in and cause fire spreading. There is limited comburent in the cabin. Keeping the hood closed can control the fire so that the fire can be easily put out). Point the on-board fire extinguisher at the ignition point from the hood gap to put the fire out, or seek help from the passing cars. If you can borrow more fire extinguishers, open the hood to put it out when you cannot see any flame from outside.
- If the fire brigade is involved, ask for a duty performance certificate and a description of fire cause.
- After occurrence of the accident, contact the insurance company for post-event handling in a timely manner.

 **REMINDER**

- In order to mitigate losses in the event of an accident, the purchase of commercial insurance (fire loss, theft, etc.) is recommended.

Snow Chains

- Snow chains are only for emergencies or areas where they are permitted by laws.
- Snow chains should be installed on rear wheels. Be careful when driving the vehicle installed with snow chains on snow-covered roads. Use thin snow chains. Some snow chains may damage tires, wheels, and the vehicle body. The recommended snow chains are no larger than 10 mm in thickness or diameter, which provides enough space between tires and other parts in the hubcap.
- Read the component assembly drawings and other instructions provided by the snow chain manufacturer carefully.
- Before purchasing and installing snow chains, consult a BYD authorized dealer or service provider where your vehicle was purchased.
- In order to minimize wear of tires and snow chains, do not travel with snow chains on roads without snow.

! REMINDER

- Driving speed must not exceed 30 km/h or the speed limit specified by the snow chain manufacturer.
- Drive carefully, paying attention to bumps, potholes, and sharp turns that can cause the vehicle to bounce.
- For vehicles with snow chains, avoid sharp turns or braking with locked wheels, and slow down the vehicle before entering a curve to avoid accidents due to loss of control.
- Install the chains symmetrically and remove them immediately

! REMINDER

- after driving on snowy or muddy roads.
- If an abnormal sound is heard from the snow chain, please stop the vehicle immediately to check whether the vehicle components such as suspension, body or brake lines are normal, and ensure that there is no contact between them and the snow chains.
- Do not install snow chains with low tire pressure.

Starting and Driving

Starting the Vehicle

In normal cases, start the vehicle as below:

- Engage the parking brake firmly.
- Shift to Park or Neutral.
- Carry the correct smart key with you.
- Press the START/STOP button ② while pressing the brake pedal ①.



- The vehicle is ready to drive when the OK indicator lights up on the instrument cluster.

The vehicle cannot power on when:

- After you press the START/STOP button, the smart key warning light turns on, a beep sounds, and the message "No key detected" is displayed on the instrument cluster. This means that the key is not in the vehicle or cannot be detected due to interference.
- The key is somewhere unsuitable for detection, such as on the floor, in the cup holder, trunk, or storage compartment.

REMINDER

- The vehicle can not be started when the electronic key is left stationary for more than 1 minutes (depending on the configuration of the vehicle).

Starting the vehicle in emergencies:

- Engage the parking brake firmly.
- Turn off all unnecessary lights and accessories.
- Switch the ignition off.
- The electronic smart key is in the vehicle.
- Press and hold the smart key start button for over 15 seconds.

CAUTION

- Do not touch the power button while driving.

Remote Start

Before starting

1. The power mode is "OFF".
2. The gearshift lever is on "P".
3. The vehicle speed is below 5 km/h.

Remote Start with the Electronic Smart Key

1. Press and hold the remote start/stop button on the electronic smart key for two seconds to start the vehicle. Turn signals will flash three times after it is started.
2. If there is no valid operation within 10 minutes after remote start, the vehicle stops and powers off, and turn signals flash twice.



3. After the vehicle is started, pressing and holding the remote start/stop button on the smart key for two seconds switches the ignition off. The turn signals then flash twice.

Driving

Preparations Before Driving

- Check the surroundings before getting into the vehicle.
- Adjust seat position, seatback angle, cushion height, headrest height, and the steering wheel angle and height.
- Adjust interior rearview mirror and side mirrors.
- Close all doors.
- Fasten the seat belts.

Safety Check Before Driving

It is advisable to carry out a safety check before driving long distance, which ensures your driving safety and enhances your driving experience. The vehicle can also be taken to a BYD authorized dealer or service provider for inspection.

Exterior

- **Tires:** Check tire pressure and carefully inspect tires for any cut, damage, foreign material, anomaly, and excessive wear.
- **Lug nuts:** Ensure all nuts are fitted and tightened.
- **Lighting:** Make sure headlights, position lights, turn signals and all other lights are working normally. Check headlight intensity.

Interior

- **Seat belts:** Check whether seat belts can be properly fastened. Verify that seat belts are not worn or scratched.
- **Instrument cluster:** Particularly, verify that maintenance indicator, instrument cluster lighting, and defroster work properly.
- **Brake pedal:** Verify that there is enough space for the brake pedal to work.
- **Low-voltage battery and cables:** Check connectors for any corrosion or looseness and any cracks in the battery housing.

In the engine compartment

- **Spare fuses:** Verify that spare fuses of all rated charges in the fuse box are available.
- **Coolant level:** Verify that coolant level is correct.

Check after starting

- **Instrument cluster:** Confirm that the maintenance indicator and the speedometer work normally.
- **Brakes:** In a safe area, drive the vehicle straight, hold the steering wheel tightly, decelerate and apply the brake. Verify that the vehicle maintains a straight direction.
- **Other abnormalities:** Check for loose parts, leaks, and unusual noises.

If everything is OK, just enjoy your driving.

Gear Shift Controls

- The gear position of the gear actuator is marked on the gearshift lever as shown on the right.
- **"P":** Parking. Press this button to park the vehicle. Shift to this position when turning the motor on or off.
 - To start the vehicle, the power status should be on "OK". Press the brake pedal and the UNLOCK button to switch from "P" to another position.

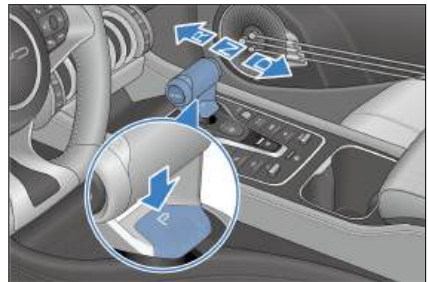

CAUTION

- To prevent damaging the transmission, press the "P" button only after the vehicle has completely stopped.
- **"R":** Reverse, used only when the vehicle has come to a complete stop.

- "N": Neutral, used for temporary stop.
 - Under all circumstances, always shift to "P" before the driver gets out.
- "D": Drive. Shift to "D" to drive the vehicle normally.
- Turn the ignition on before shifting into "D".
- Shifting out of "P" or into "D" gear requires pressing the brake pedal and the UNLOCK button at the same time. For details, see the prompt message on the instrument cluster.
- If the shift is successful, the lever returns to its middle position after it is released.
- To prevent unintended vehicle movement, press the "P" button and engage EPB once the vehicle has stopped completely. At this time, the EPB indicator turns on.

WARNING

- Transmission may be seriously damaged due to lack of lubrication if the vehicle is allowed to move for too long after the motor is turned off and "N" gear is engaged.
- When the motor is running and the vehicle is in the "R"/"D" gear, always stop the vehicle by stepping on the brake pedal, as there is still force transmitted from the actuator and the vehicle can travel slowly even in its idle condition.
- If you want to shift a gear while driving forward, do not step on the accelerator pedal to prevent accidents.
- Never shift to "R" or press the "P" button while the vehicle

WARNING

is moving, in order to prevent accidents.

- It is not recommended to allow the vehicle to go down a ramp when it is in the "N" or "P" gear, even if the vehicle is not started.

Electronic Parking Brake (EPB)

EPB Switch

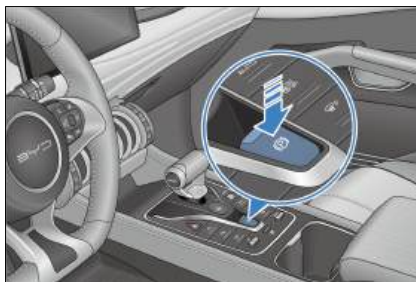

- Be sure to engage the Electronic Parking Brake (EPB) every time before parking and leaving the vehicle.



Engaging EPB Manually

Pull up the EPB switch. EPB applies an appropriate parking force, and  flashes on the instrument cluster and then becomes solid on, indicating that EPB has been applied. The "EPB ON" message is also displayed.

CAUTION

- When  flashes, EPB is working. If the vehicle is on a slope, do not release the brake pedal until  is steady on. Otherwise the vehicle may move down.

Engaging EPB Automatically

Switching the ignition off

- When the ignition is switched off, EPB engages automatically and  lights up on the instrument cluster.

Shifting into Park

- Press the brake pedal to stop the vehicle and shift into Park. EPB is engaged automatically. Do not release the brake pedal until the indicator on the instrument cluster stops flashing and becomes steady on and the "EPB ON" message is displayed.



CAUTION

- The EPB is not automatically engaged if you switch off the ignition immediately after pressing the EPB switch. This function may be used for towing or pushing the vehicle after the vehicle breaks down.
- Do not release the brake pedal early in the process, especially when the vehicle is stopped on a slope; otherwise the vehicle may slip back.
- This function is designed to improve vehicle safety. Excessive reliance on or frequent use of the function is not recommended. For safety reasons, make sure that the vehicle is shifted into "P" or the EPB is engaged before getting off.
- The EPB system conducts power-up self-check within several seconds after the vehicle is started. In this process, the system does not respond to any function.

Releasing EPB Manually

- When vehicle has been powered on and is not shifted into P (Park), press and hold the brake pedal and the EPB switch until the indicator on the instrument cluster goes out, indicating EPB has been released, and an "EPB released" message is displayed.



CAUTION

- The P gear is the vehicle's parking gear, meaning that the vehicle is in a stable parking status, while EPB is the vehicle's main parking device. To ensure parking safety, release EPB with the EPB switch only when the vehicle is not in P gear (parking gear).

Automatic EPB Release upon Vehicle Start

- With the vehicle parked, start the vehicle, press and hold the brake pedal, and shift from "P" or "N" into a driving gear such as "D" or "R". EPB is released automatically, the indicator goes off, and the "EPB released" message is displayed.



CAUTION

- Be sure to always press and hold the brake pedal when shifting gears. Release the pedal only after the intended gear is displayed on the instrument cluster.
- When the vehicle has been started and the gear is in a driving gear such as "D" or "R", engage EPB manually, then simply press the accelerator pedal slowly to a certain degree. EPB is released automatically and  turns off with the message "EPB released" displayed.

WARNING

- For safety considerations, refrain from using EPB for braking in normal driving. It is preferred to be used when the brake pedal fails or is blocked.
- As the EPB cannot go beyond the physical limit of road adhesion, activating the emergency brake function may result in vehicle drift, sideslip, or deflection when the vehicle passes through bends or dangerous/heavy-traffic road sections, or when the vehicle is driven under severe weather conditions. Be careful to avoid any possible accident.

If EPB Release Fails

- If manual EPB release fails, press and hold the EPB switch for over two seconds. If EPB can be released, drive the vehicle to the nearest repair shop to check the brake pedal switching signal and relevant parts and lines. If it cannot be released, contact a BYD authorized dealer or service provider immediately.

Emergency Braking When Brake Pedal Fails

- If braking fails or is blocked, continue to press P gear switch for more than 2S for emergency braking.

CAUTION

- For safety considerations, refrain from using the "P" gear switch for emergency braking in normal driving. If the brake pedal fails or is blocked, use the emergency braking function while you can

CAUTION

always keep the vehicle under control and drive normally.

EPB System Indicator

- When the vehicle is powered on, if the EPB is engaged, (P) is solid on on the instrument cluster.
- When the vehicle is powered off, if the EPB is engaged, (P) comes on and then turns off in about three seconds.
- When the vehicle is powered on, the EPB system starts self-check. The indicator (P) on the cluster turns on and then turns off in about three seconds. If it does not, the EPB or braking system may be faulty. It is recommended to contact a BYD authorized dealer or service provider for inspection as soon as possible.

EPB Operating Sound

- EPB motor noises can be heard while the EPB is being engaged or released.
- If there is a burning smell or unusual noise after emergency braking is activated, contact a BYD authorized dealer or service provider immediately.

WARNING

- To prevent the vehicle from moving, do not the replace EPB with the gearshift when parking. EPB must be used instead, and the vehicle must be in "P" gear.
- To prevent a serious accident, never allow any passenger in the vehicle to operate the EPB switch when the vehicle is running.

WARNING

- When the EPB switch is pulled or released, the brake pedal must be pressed to prevent the vehicle from moving, and the subsequent locking of the gearshift that occurs because EPB cannot provide a sufficient parking force.

Automatic Vehicle Hold (AVH)

Automatic vehicle hold (AVH): The automatic vehicle hold (AVH) is activated automatically when the moving vehicle needs to be stationary for longer periods of time, such as in traffic jams on a slope or waiting at traffic lights.

AVH standby

- When the ignition is on, press the AVH switch to enable the function. The AVH standby indicator  is displayed on the instrument cluster.
- Press the AVH switch again to disable AVH.

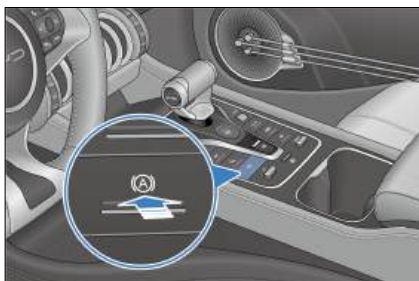

AVH activated



- When the AVH standby indicator  is solid on, press and hold the brake pedal until the vehicle stops (vehicle speed reduces to zero) to activate AVH. At this time, the vehicle is in AVH state

with  displayed on the instrument cluster.

CAUTION

- For AVH to be activated, all of the follow conditions must be met:
 - The driver's seat belt is fastened and the doors are closed.
 - Intelligent power braking system and electronic park brake (EPB) systems are normal.
- Pressing the accelerator pedal, shifting into Park, or engaging the EPB manually can make AVH exit to the standby status.
- The AVH is off by factory default.

AVH running

- The AVH function runs normally when it is activated, brake lights and the high-mount brake light are on, and the AVH indicator  is solid on on the instrument cluster.
- The AVH function exits to the standby mode after the vehicle stops for 10 minutes, with the AVH standby indicator  lighting up and gear shifted into Park.
 - Shift into “D”, drive the vehicle normally, then press and hold the brake pedal until the vehicle stops (vehicle speed reduces to zero) to activate AVH.

AVH exits

- When the AVH function runs normally, the following actions make AVH exit and shift the vehicle from Drive to Park automatically:
 - Open the driver's door.
 - Unlock the driver's seat belt.

- The gear status is in Drive when the vehicle stops, and EPB is enabled.
- Press the AVH switch again to disable AVH when releasing the brake pedal.

AVH suppressed

- Shifting into Reverse, AVH goes into slow-moving condition. When the vehicle is reversing (in Reverse) or shifts from Reverse into Drive to travel at a low speed, AVH cannot be activated but stays on standby to facilitate low-speed vehicle motion.
- To exit slow-moving mode, push the AVH switch or drive at a speed above 10 km/h. The AVH function is on standby and can be activated normally.

Driving Precautions

- Drive slowly and carefully along gravel roads. To prevent tire damage, do not drive over sharp-edged obstacles.
- Slow down on bumpy or uneven roads. Otherwise, the impact may seriously damage wheels.
- Avoid driving through flooded areas as much as possible.
- Slow down when driving against strong winds.
- Cleaning the vehicle or driving through deep water may wet brakes. To keep brakes dry, drive carefully and press the brake pedal gently.
- Drive carefully on slippery roads, such as roads covered in ice, snow or sand, or surfaces such as wet ceramic tiles or epoxy resin. Avoid parking on slopes to prevent vehicle sliding.

WARNING

- The high-voltage battery is located in the vehicle's chassis.

WARNING

Make sure to avoid bumping when driving.

- The driver shall ensure the riding safety of all passengers in the vehicle, guide them to correctly use vehicle features, and prevent children and other passengers operating in a wrong way.
- Make sure no occupant sticks their head or hands outside the vehicle, specially when it comes to children.
- Be careful when accelerating or braking on slippery roads. Quick acceleration or sudden braking will cause the vehicle to skid or deviate.
- Do not leave the vehicle with ignition on.
- Remember to carry the smart key when leaving the vehicle.

CAUTION

- Before driving, make sure that EPB is fully released and that the EPB indicator light is off.
- Slow down when driving down steep slopes, and avoid braking too frequently to prevent disc overheating, which affects brake performance.
- Large amounts of water entering the engine compartment can cause damage to the power system and electrical components.

Winter Driving Precautions

1. Make sure the coolant is freeze-proof.

- Use coolant of the same type as the one used originally. Fill up coolant into the cooling system based on ambient temperature.
 - Improper coolant damages the cooling system.
2. Check batteries and cables conditions.
 - The low-voltage battery's capacity is lower in cold weather, so they must be fully charged when winter comes.
 3. Avoid door frost.
 - Spray some deicing agent or glycerin in the lock hole to prevent freezing.
 4. Use anti-freeze washer fluid.
 - These can be found in the BYD authorized dealer or service provider and the auto parts stores.
 - The water and anti-freeze ratio must conform to manufacturer instructions.



CAUTION

- Use special washer fluid to prevent paint damage.



5. Prevent ice and snow from going under the fender.
 - Steering is difficult with ice or snow accumulating under the fenders. When driving in cold weather, stop from time to time and check for snow and ice under the fenders.
6. Have emergency tools or items available as prevention for difficult road conditions.
 - It is advisable to have snow chains, window scraper, bags of sand and salt, flashing signal, a shovel and connecting cables in the vehicle.

Driver Assistance

Adaptive Cruise Control (ACC)*

- The adaptive cruise control (ACC) system, an extension of the traditional regular cruise control, uses a radar to detect the relative distance and speed of the vehicle ahead, so as to control vehicle speed accordingly. The system switches between regular cruise control and ACC depending on whether there is a vehicle ahead.
- Cruise speed and time interval from the vehicle ahead can be set by using the cruise buttons. Cruise control speed can be set within a 30 to 150 km/h (20 to 95 mph) range, or a fixed distance from the vehicle ahead can be set to cruise at speeds between 0 and 150 km/h (0 to 95 mph).

Status Description

- ACC off:
 - ACC system is disabled. To access the function, enable the ACC system first.
- ACC standby:
 - Once enabled, the system is on standby by default and can be manually activated. If the vehicle does not meet activation conditions, it must be checked until such conditions are met. At this time,  is displayed on the instrument cluster.
- ACC activated:
 - The system is operational. It maintains the set speed or automatically adjusts the distance from the vehicle ahead. At this time,  is displayed on the instrument cluster.

- Over speed:
 - If the accelerator pedal is pressed with ACC activated, ACC will enter over speed mode until the accelerator is released.
- ACC failure:
 - There has been a failure in the system. No operation can be performed, and the ACC failure indicator  lights up on the instrument cluster.

ACC Activation Conditions

- The EPB has been released.
- The vehicle is in Drive.
- The vehicle does not slide backwards.
- All doors, hood, and trunk are closed.
- Driver seat belt is fastened.
- The ESC system is on, but not activated yet.
- The vehicle speed is not greater than 150 km/h (95 mph).
- Brake pedal is pressed at speed 0; or brake pedal is not pressed at speeds above 0.
- There is no vehicle network communication failure prompt on the instrument cluster.
- The AEB function is not activated.

Cruise Button Operation

ACC on/off button

Press button ① to activate or exit ACC. (The system is in standby when activation conditions are met).

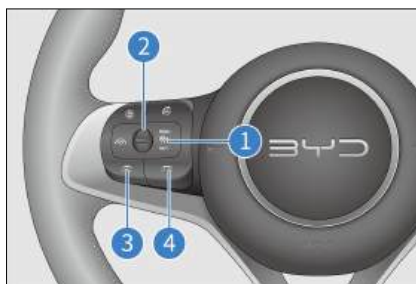

Resetting ACC

When the ACC system is in standby within the same ignition cycle, the system memorizes the last speed setting. Push up the rocker switch ② to revert to the stored speed prior to exiting the cruise system last time. If no cruise speed is stored, the vehicle travels at current speed.

Increasing/Decreasing target speed

- If the rocker switch ② is toggled, ACC will set the current speed as the target speed when it is activated from standby. If the current speed is below 30 km/h or 20mph, the target speed will be set to 30 km/h or 20mph; and if the current speed is above 150 km/h or 95mph, the target speed will be set to 150 km/h or 95mph.
- When ACC is active, vehicle speed can be set within a 30–150 km/h (20–95 mph) range by toggling the rocker switch ②. Toggling the rocker switch ② up or down increases or decreases target speed by 5 km/h.

Exiting ACC

Pressing the brake pedal makes the ACC system go on standby. Press button ① again to exit ACC system.

Setting vehicle distance

- The driver must select a safe vehicle distance.

- The system adjusts vehicle speed to keep a suitable distance from the vehicle ahead on the same lane. Pressing buttons ③ and ④ on the steering wheel adjusts vehicle distance to any of the four available levels. At each level, vehicle distance is in direct proportion to vehicle speed. The faster the speed, the longer the distance.

Increasing/Decreasing speed with ACC active

- When ACC is activated, you can press the accelerator pedal to reach the set target cruise speed in advance. The system then enters over speed mode. At the target cruise speed, if you accelerate without performing any other operations, the vehicle accelerates and then returns to target cruise speed after the accelerator pedal is released. If the rocker switch ② is pulled down while the vehicle is accelerating, the current speed will be reset as the target cruise speed. If the speed goes above 150 km/h, or the accelerator pedal is pressed and held for over 15 minutes, the system goes into standby mode and the ACC needs to be reactivated.
- When you press the brake pedal with ACC activated to slow down the vehicle, ACC goes into standby mode. After the brake is released, ACC needs to be reactivated.

Follow-to-stop/start

- Controlled by ACC, the vehicle can stop when the vehicle ahead stops in normal driving conditions and resume driving automatically following the vehicle ahead if the stop is less than three seconds.
- If the vehicle stops for less than three minutes, press the accelerator pedal or using the ACC cruise button to reactivate ACC.

- If the vehicle stops for more than three minutes, the ACC system will enter standby mode, with EPB engaged.

Precautions

- ACC is a comfort system rather than a safety system, obstacle detector or collision warning system. The driver must keep control of vehicle at all times and be fully responsible for the vehicle.
- The ACC assists the driver, but is not a substitute for the driver. Drivers must abide by traffic rules and keep vehicle control at all times and be fully responsible for their vehicles.
- Traffic flow and weather conditions - such as rain and fog - must be heeded for setting vehicle distance on the ACC system. After the ACC system is properly set, the driver must be able to decelerate until the vehicle stops at any time.
- The ACC is suitable for motorways and roads in good conditions, rather than complex urban or meandering roads.
- Vehicle control is transferred to the driver if the accelerator or brake pedal is pressed with ACC active. As a result, ACC system distance control will not be activated.
- Only in special and very specific conditions, ACC can respond to stationary or slow-moving objects, such as vehicles, the end of traffic, toll booths, bicycles or pedestrians.
- For safety reasons, ACC cannot be activated with ESC disabled.
- The ACC system cannot identify pedestrians or oncoming vehicles.
- The ACC system can only achieve limited braking instead of emergency braking.

- The ACC may have no or slow responses to a vehicle ahead that brakes suddenly (emergency stop), resulting in a risk of late braking. In such cases, there will be no take-over request.
- In some cases, such as when the vehicle ahead is going too slow, when lane change of your vehicle is too fast, or when the safe distance from the vehicle ahead is too short, there is no adequate time for the system to decrease the relative speed, so response has to come from the driver. The system cannot give audible or visual warnings in every case.
- Reaching or leaving a curve may delay or disturb target selection. In these cases, the ACC vehicle may not brake as expected or may brake late.
- On roads with sharp bends, such as winding roads, the vehicle ahead may be out of ACC sensor detection, so ACC may accelerate.
- A short distance from an adjacent lane (or a vehicle on an adjacent lane that is too close to the ACC vehicle's lane) may trigger ACC to brake.
- Vehicles coming into the ACC vehicle's lane and within its radar detection range are identified as target vehicles and prompt a response accordingly, which may lead to hard or late braking.
- Detection may be affected or delayed in some environments. If the radar cross section of the target (a bicycle, four-wheeler, or pedestrian, for example) is too small, the system may not be able to establish its distance, resulting in either late or no response to those vehicles. In such cases, vehicle speed must be controlled by the driver. In addition, detection may also be affected or delayed by noise or electromagnetic interference.
- If the contact ratio of your vehicle with the vehicle ahead is too small, ACC will not be able to recognize the latter as a target, so the driver must keep control of the vehicle.
- When the vehicle stops as it follows a vehicle ahead, in rare cases, the system will not recognize the end of the vehicle ahead but the lower end of the target (e.g. the rear axle of a truck with a high chassis or a vehicle bumper). In such cases, the system cannot ensure proper stop distance, so the driver must stay alert and be ready to brake.
- If ACC is activated with the vehicle stationary, the system identifies any stationary obstacle ahead and keeps the vehicle still to ensure a safe startup and prevent collision. However, this function cannot identify all the obstacles, so the driver must be alert to the front obstacles or other traffic participants.
- The radar sensor performance may be affected by vibration or collision. In this case, it is recommended to contact a BYD authorized dealer or service provider.
- The radar is installed at the front area of the vehicle. Blockage of its detection area by contaminants disturbs the intended function. In particular, if the sensor is covered by snow completely, the ACC system exits and informs of this on the instrument cluster. System function will recover after blockage is removed and the vehicle is restarted or runs on normal roads for a while.
- Front radar sensors may have a transient function failure from limited detection if the vehicle runs under special conditions, such as circular ramps or tunnels, for an extended period. The function can be recovered by restarting the vehicle or driving on normal roads for a while.



- Modifying the vehicle structure, such as lowering the chassis or changing the front license mounting plate, may affect the ACC system.
- Metal objects, such as rail or metal plates used in road construction, may interfere with the medium range radar, making it malfunction.
- Do not use the ACC system when visibility is poor, or when driving on slopes, winding roads, or wet roads (covered in ice/snow or flooded).
- In any of the following situations, it is recommended to go to a BYD authorized dealer or service provider for professional calibration and verification of the medium range radar:
 - Removal of front medium range radar or front bumper.
 - Wheel alignment has been carried out.
 - The vehicle has experienced a collision.
 - ACC system performance has degraded or the instrument cluster has prompted a system error.

Intelligent Cruise Control (ICC)*

- The Intelligent Cruise Control(ICC) system integrates ACC and Lane Keeping System(LKS). It helps control the vehicle both longitudinally and transversely at speeds between 0–120km/h or 0~75mph to reduce the driving burden and provide a safe and comfortable driving environment.
- When the function is enabled, the driver must always hold the steering wheel and control the vehicle when necessary.

- Users may enable or disable the ICC function by using its switch. When the vehicle is started, the system defaults to previous settings.



- When the ICC function is enabled, the standby state indicator lights up on the instrument cluster: 
- When the ICC function is activated, the activated state indicator lights up on the instrument cluster. 
- With the ICC function enabled and the ACC function activated, when vehicle speed is between 0 km/h and 60 km/h:
 1. If the lane lines on both sides of the vehicle are present and recognized:
 - The vehicle keeps at the center of the lane, regardless of vehicles ahead.
 2. If the vehicle enters a road section where lane lines become unclear or absent:
 - If there is a target vehicle ahead, the vehicle follows it and moves slightly from side to side.
 - If there is no target vehicle ahead, the ICC function will be suppressed and only ACC will work.
- With the ICC function enabled and the ACC function activated, when vehicle speed is between 60 km/h and 120 km/h:
 1. If the lane lines on both sides of the vehicle are present and recognized:

- The vehicle keeps at the center of the lane, regardless of vehicles ahead.
2. If the vehicle enters a road section where lane lines become unclear or absent:
- ICC function is suppressed regardless of target vehicles ahead and only ACC works.

 **CAUTION**

- When the system is on, if the driver's hands leave the steering wheel for about 15 seconds, the system will prompt the driver to take over the steering wheel. If the driver does not take over, it will exit ICC mode.
- The ICC system is a driving assistance system, not an automatic driving system. The driver should keep control of vehicle at all times, and their hands should not leave the steering wheel for a long time. Otherwise, the system will exit after prompting the driver to take over the control.
- The ICC system can be affected by weather conditions, lighting and clarity of lane lines. Performance degrades significantly in situations such as backlighting, sunset, snow covered roads, and severely damaged roads.
- The ICC system integrates the functions of ACC system and LKS. Therefore, it is necessary to follow relevant precautions for ACC and LKS when you are using ICC.

Predictive Emergency Braking (PEB)*

The predictive emergency braking (PEB) system has two features: Pedestrian Collision Warning (PCW) and Automatic Emergency Braking (AEB). It uses radar and multi-purpose camera to detect with vehicles ahead or pedestrians. When detecting a risk of collision, the system gives audible and visual alarms to alert the driver and improve the potential braking pressure for better response timing. If detecting increased risk of collision, the system automatically applies braking pressure to assist in collision avoidance or impact reduction.

How to Use

Enable or disable the PCW in  → **ADAS** → **Active Safety**. By default, the system is switched on when the vehicle is started.

PCW

- Safe distance warning

If the vehicle is too close to the vehicle ahead at speeds above 65 km/h for too long, the system gives a safety distance warning, and  lights up on the cluster.

- Pre-warning

If the vehicle travels at speeds between 30 and 150 km/h and the system recognizes a risk of collision with a vehicle ahead, the system will give a warning visually and audibly, and the indicator  on the cluster will light up and the buzzer will alarm. The driver needs to promptly take appropriate actions to ensure safe driving distance.

- Emergency warning

If the vehicle travels at speeds between 30 and 150 km/h and the driver fails to promptly respond to the pre-warning,

the risk of collision increases, and the system will give a warning visually and tactilely. The indicator  flashes and there may be a short braking warning. The driver needs to promptly take appropriate actions to ensure safe driving distance.

AEB

- If the driver fails to respond to the emergency warning and the risk level increases, the system will enable the AEB function. It engages braking force as much as possible to avoid collision or reduce crash impact.
- If the driver applies insufficient braking force in an emergency, the braking system provides additional braking force to reach the optimal level required to avoid collision or reduce crash impact.

System Limitations

- Detection may be affected or delayed in some environments. If the radar reflection cross-sectional area of the target (a bicycle, three-wheelers, four-wheeler, or motorized bicycle, or motorcycle, for example) is too small, the system may not be able to establish its distance, resulting in either late or no response to those vehicles.
- In the following cases, PEB system may be affected or give no response:
 - On rainy, snowy or foggy days, large water splashes, or exposure to direct sunlight or glaring lights, or significantly varying lighting conditions.
 - Dirty, hazy, damaged or blocked sensor.
 - Radar failure due to interference from other radar sources, such as strong radar reflection in multi-storey car park.

- In complex traffic, the system may be unable to properly respond to the following circumstances:

- Pedestrians or vehicles move too quickly into the sensor's detection range.
- Pedestrians are obscured by other objects.
- Pedestrian outlines are indistinguishable from the surroundings.
- Pedestrians are not detected, due to, for example, coverage by special clothing or other materials.
- The vehicle is on a sharp curve.

Precautions

- The PEB system cannot ensure zero collision. In complex traffic, the system cannot always clearly identify all the vehicles or pedestrians. It may trigger unnecessary warning or braking action for well covers, iron plates or road signs.
- Make sure to drive safely and observe surrounding traffic conditions. The AEB is not a substitute for normal braking operation in any event.
- Do not overly rely on the PEB system as this may result in severe injuries or deaths. The system is only an auxiliary safety tool. The driver must always keep a safe distance from vehicles ahead, control the speed, and be ready to brake or steer away when necessary. The driver must keep control of the vehicle at all times and be fully responsible for safe driving.
- The AEB system is activated at vehicle speeds above 4 km/h, but it can only reduce vehicle speed by up to 45 km/h. Careful driving is always required, because the system may not be triggered correctly.



- The AEB system cannot work normally when the ESC function is disabled or the fault light is on.
- If PCW gives an alarm, the driver must brake based on traffic conditions to decrease vehicle speed or steer away from obstacles.
- If the vehicle travels too close to the vehicle ahead for too long, a safety distance warning will be given. If the vehicle ahead brakes suddenly, collision may be unavoidable.
- The system will not trigger AEB when the driver is aware of an emergency warning but turns the steering wheel, accelerates or brakes.
- The radar sensor may have a transient function failure from limited detection if the vehicle runs under special conditions, such as circular ramps or tunnels. The function may be recovered by restarting the vehicle or driving on normal roads for a while.
- Sometimes the sensor or multi-purpose camera detect dirt or foreign matter on its surface. In this case, a message is displayed on the instrument cluster and both PCW and AEB are disabled. The functions will recover after the sensor or camera is cleaned.
- The pedestrian protection function is limited by certain physical conditions and it may not be able to take effect within the 4-60 km/h speed range as required. Therefore, the responsibility to use brakes timely and effectively always lies in the driver. Pedestrian protection warnings and preventive braking depend on the actual situation.
- The system cannot completely protect pedestrians or avoid accidents and severe injuries on its own.
- Under certain complex conditions, such as on winding roads, the pedestrian protection function may trigger unnecessary warning or braking.
- In case of system failure due to radar or multi-purpose camera misalignment, the pedestrian protection function may trigger unnecessary warning or braking.
- The brake pedal becomes harder when AEB is triggered. A large amount of hydraulic pressure will be required to push the caliper in a short time and there will be a sizzling noise.
- The PEB system is triggered only when the doors are closed and the seat belt is fastened. In the following circumstances, it will fail to work in the following cases:
 - Any door is not closed or it is opened when the vehicle is moving.
 - Any seat belt has not been fastened or it is unfastened while the vehicle is traveling.
 - The driver brakes hard.
 - The driver presses the accelerator pedal.
 - The drivers frequently switches between the accelerator and brake pedals.
- System performance may be reduced in the following cases:
 - Strong front bumper impact from accidents or other causes.
 - Improperly inflated or worn out tires.
 - Unqualified tires installed.
 - Snow chains installed.
 - Use of a small spare tire or tire repair kit.

- Make sure to go to a BYD authorized dealer or service provider for professional calibration of medium range radar in any of the following situations:
 - Removal of medium range radar or multi-purpose camera.
 - Toe-in or rear camber has been adjusted during wheel alignment.
 - The vehicle experienced a collision.
 - ACC system performance has degraded or become abnormal.
- Do not attempt to test the PEB system on your own using objects such as carton, iron plate, dummy, etc. The system may not work properly and thus result in accidents.

Traffic Sign Recognition (TSR)*

The Traffic Sign Recognition(TSR) system identifies speed limit signs on the road through the multi-purpose camera. When the speed limit icon on the instrument cluster lights up, it means the vehicle speed should be within range.

How to Use

- Enable or disable TSR in the infotainment touchscreen →  → ADAS. When the vehicle is started, the system defaults to previous settings.
- When the system identifies a speed limit sign, the speed limit icon identified displays (such as ) on the instrument cluster. When the instrument cluster shows the speed is over 5 km/h above the identified speed limit, the icon on the instrument cluster flashes to alert the driver. When the system identifies the end of speed limit icon or after the vehicle

travels for a while, the speed limit icon disappears.

Precautions

- The speed limit icon disappears from the instrument cluster within a certain distance after system recognition. The driver must control speed within range.
- The TSR system can identify speed limit signs only, and will not control speed. The control over the vehicle always vests in the driver. Please drive properly.
- When there are several speed limit signs on side-by-side lanes, the system recognizes the limit sign of current lane to display the speed limit alert icon. The driver must remain in the correct lane.
- Weight limit signs not in standard size as per national regulations may mistakenly be identified as speed limit signs.
- If a speed limit sign is unclear or distorted, inclined, reflective, partly blocked or covered, the camera may be unable to recognize the sign completely or clearly.
- TSR performance depends on weather conditions, lighting, and sign visibility. The system may fail to or incorrectly identify the sign at night or sunset, in rainy, foggy, hazy, snowy or dusty environment, when light is coming from the back of the vehicle, or when there is a sudden change in lighting.
- In case there is a collision or the camera sensor has been reassembled, it is recommended to go to a BYD authorized dealer or service provider for sensor calibration so as to avoid affecting system performance.

 **WARNING**

- TSR serves as a driver assistance function only, so the driver must be fully responsible for driving safety.
- Influence of weather, road conditions, and other factors may cause TSR to fail or lead to late alarms.
- Use TSR based on your needs, traffic, and road conditions.

Lane Support System (LSS)*

- Lane support system (LSS) includes lane departure warning (LDW) and lane departure prevention (LDP) functions.
- LDW detects the lane lines ahead through a multi-purpose camera. When speed is above 60 km/h, the system notifies of the lane departure with visual, audible and vibration warnings.

- LDP provides steering assistance to prevent departure.
- When the emergency lane keeping assist (ELKA) is activated, the system will provide reverse torque or steering angle to control vehicle steering and help the driver keep the vehicle in its current lane when it is about to depart from a lane (solid/dashed line), in order to prevent it from crossing the edge of the road or colliding with oncoming or overtaking vehicles in the adjacent lanes.
- Enable or disable this function in  → **ADAS** → **Driving Assist** → **Lane Support System (LSS)**. When the vehicle is started, the system defaults to the previous settings.
- Alarm mode: audible warning only, or steering wheel vibration*, or combination*.

Instrument Cluster Prompt

After the LSS is enabled, lane boundaries will appear on the instrument cluster.

Lane boundary	
Gray	Function enabled, no lane boundary identified.
Green	Function enabled, lane boundary identified.
Red	Function enabled. Vehicle offsets when driver does not change lanes. The vehicle alarms according to the settings, prompting the driver to correct the direction promptly.

System Limitations

- The LSS may detect incorrect or no lane lines in complex traffic. The following situations may lead to failure or performance degradation of the system:
 - Poor visibility on snowy, rainy, or foggy days
 - Dirty or fogged front windshield, or blocked multi-purpose camera
 - Glaring from direct sunlight, reflection in puddles, or oncoming vehicles
 - Sudden changes in light, such as when the vehicle is entering or exiting a tunnel

- Unidentifiable lane markings with shadows cast by the fence
- Unidentifiable road boundary with grass, soil, or curb

Precautions

- LSS will be suppressed if a turn signal is used and the vehicle changes lane as indicated by the turn signal.
- LSS may be suppressed if the vehicle travels over lane lines or if lane lines are unclear, too thin, worn, blurred, or covered by dirt/snow.
- LSS may be suppressed if the lane is too wide or too narrow, if the number of lanes increases or decreases, if lane markings change suddenly on ramps or exits, or in situations of complex line arrangements.
- LSS may be suppressed on slopes or winding roads when the vehicle travels too close to the vehicle ahead or when the vehicle ahead blocks lane lines.
- LSS may be suppressed when the vehicle jolts, accelerates or decelerates too quickly, or takes a sharp turn.
- The system operation may be affected if the windshield within the visual field of the multi-purpose camera is cracked, if the windshield glass is dyed or inadequately coated, if any reflective object is placed on the dashboard, or if any other object interferes with camera sight.
- For safety reasons, do not test LDW function on your own. The function will be interrupted if the multi-purpose camera is blocked by any object or exposed to strong lights. The function recovers once conditions return to normal. If it does not, it is recommended to contact a BYD authorized dealer or service provider.

- Disabling LSS is recommended in the following circumstances:
 - Driving in a sporty style.
 - Severe weather conditions.
 - On uneven roads.

Blind Spot Detection (BSD) System*

The Blind Spot Assist(BSA) system includes the following functions: blind spot detection (BSD), door open warning (DOW)*, rear collision warning (RCW), rear cross traffic alert (RCTA), and rear cross traffic braking (RCTB). It recognizes current traffic conditions through radar sensors so as to remind the driver of safe and careful driving.

How to Use

Enable or disable BSD in  → **ADAS** → **Active Safety**. When the vehicle is started, the system defaults to previous settings.



Blind Spot Detection (BSD)

When speed is above 15 km/h and the sensor detects a vehicle within the blind spot of a side mirror or approaching quickly on the adjacent lane, its indicator lights up. If the turn signal for the same side is turned on at this moment, the alarm indicator on the side mirror flashes to alert the driver of a risky lane change.

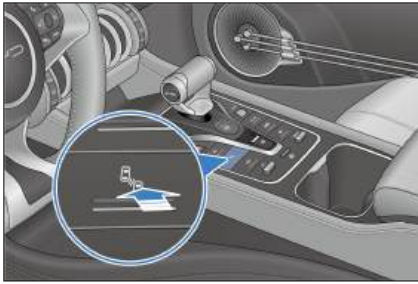

Door Open Warning (DOW)*

- The Door Open Warning(DOW) system detects conditions that may endanger vehicle safety from the rear when the vehicle stops and a door is about to open, and gives a light warning.
- The rear radar recognizes targets within close range from the rear and on both sides, detects conditions that may endanger vehicle safety from the rear, and alerts you with a warning light.
 - Detection targets include non-power-driven vehicles such as bicycles, electric scooters, three-wheelers, motorcycles, powered vehicles such as trucks, sedans and buses, as well as pedestrians and other moving objects that may endanger traffic safety.

Rear Collision Warning(RCW)

At vehicle speeds above 5 km/h, if radar sensors detect a risk of collision with a vehicle approaching quickly from behind on the current lane, the vehicle hazard warning light and the side mirror warning indicators* flash to timely alert the driver. An alarm will sound to warn the driver of the approaching vehicle of collision risk.

Rear Collision Traffic Alert(RCTA)

- RCTA helps the driver check the transverse cross areas on both sides at the back of the vehicle. When the vehicle moves backward, it tells

the driver whether there is a vehicle approaching from behind.

- When the vehicle is reversing, the RCTA system detects the vehicles traveling in the blind spot at the back through radar. If the RCTA system believes other vehicles approaching in the back may crash into the vehicle, it turns on the spot indicator on the side mirrors so that the driver can reduce collision risk.

Rear Cross Traffic Braking(RCTB)

- RCTB is used if the vehicle meets another vehicle crossing the road when leaving a vertical/slanted parking space. It gives a warning and helps the driver brake to prevent collision, especially when the visual field of the driver is blocked by the vehicle parking beside.
- When the vehicle backs up, the RCTB system receives input from the rear left/right radar sensors and evaluates collision risk and time with the corresponding target.
- Within radar detection range and based on the measured distance to the target, relative speed and approach angle, the RCTB system identifies the level of collision risk and automatically brakes the vehicle or helps the driver brake manually.

CAUTION

- The BSD system assists the driver in monitoring side mirror blind spots, but it cannot replace the driver's subjective observation and judgment. The driver must maintain control of the vehicle at all times, and is fully responsible for the vehicle.
- When a target vehicle is approaching from behind at a

**CAUTION**

high speed, the BSD system may not be able to provide adequate warning.

- The driver should ensure the normal operation of the BSD system, keeping the BSD radar sensors in good condition. For example, if they are covered in dirt, snow or other obstructions, they need to be cleared right away
- Detection may be affected or delayed in some environments, and when the radar cross-sectional area of the target vehicle is too small (it may be a bicycle, electric moped or pedestrian), the system will not be able to identify risk, leading to false alarms. In addition, detection may be affected by noise or electromagnetic interference, resulting in delays.
- If unrelated targets at the side rear or rear (such as large roadside barriers used during road repair, large advertisement billboards by the road, reflectors in tunnels, or other objects with a large reflection cross-sectional area) are wrongly selected as targets, the BSD system will issue an alert.
- Under some circumstances, it will be difficult for the system to assist the driver and the detection system may be affected or delayed. Possible circumstances include, but are not limited to:
 - The car coming from the rear suddenly changes lanes;
 - Sharp turns, slopes and other scenarios may delay target detection;

**CAUTION**

- Relative target speed above 80 km/h;
- The target vehicle is obscured;
- When the radar reflection cross-sectional area of the target vehicle is too small (it may be a bicycle or electric moped);
- The curve radius is too small, or when entering or exiting a curve;
- Severe weather, such as rain or snow.
- BSD sensor calibration may be affected by vibration or collision, which will degrade the system's performance. In this case, contact a BYD authorized dealer or service provider.

Radar compliance statement

Radar sensor models:

77V12FLR: FCC ID: WU877V12FLR

77V13CRN: FCC ID: WU877V13CRN

Compliance statement:

- This device complies with Part 15 of the FCC Rules. Operation is subject to the following two conditions:
 - This device may not cause harmful interference.
 - This device must accept any interference received, including interference that may cause undesired operation.

**REMINDER**

- Changes or modifications not expressly approved by the party responsible for compliance





REMINDER

could void your authority to operate the device.

Tire Pressure Monitoring

System Descriptions

- The Tire Pressure Monitor System (TPMS) consists of a tire pressure monitoring module, a tire pressure monitoring control module, and a display. It monitors tire pressure in real time and issues visual and sound alarms improving safety and comfort and reducing tire wear and power consumption due to insufficient tire pressure.
- You can access the instrument cluster menu by pressing the  button on the steering wheel, navigate to the driving information bar by pressing the  and  buttons, and then select the tire pressure display screen using the scroll button.
- For standard pressure values, see the vehicle data in section Specifications.

Basic Functions

- Power-on alarm

- If tire pressure is low when the vehicle is powered off, a low pressure alarm prompts the driver to inflate when the vehicle is powered back on.
- Low tire pressure alarm
 - When the system is running, once any of the four tires has a pressure below 80% of the standard tire pressure, the TPMS gives a low tire pressure alarm within one minute and indicates the tire position.
 - In that case, inflate the tire to the standard pressure. The alarm stops when the tire pressure is above 95% of the standard tire pressure.
- Fault alarm
 - When the system is running, an alarm is given if it is running.
- Real-time tire pressure display
 - When the TPMS is running, the pressure value of each tire is displayed.
- Vehicle speed range in which the TPMS operates normally: 30 km/h - 160 km/h.

Alarm Display Descriptions

Tire pressure fault warning light: 

Alarm	Display Mode	Solution
Low tire pressure	<ol style="list-style-type: none"> 1. The tire pressure fault warning light turns on. 2. The tire pressure value turns yellow. 	Check for slow air leakage and inflate the tire to the correct pressure value.
Abnormal signal	<ol style="list-style-type: none"> 1. The tire pressure fault warning light flashes and then is steady on. 	Check the tire pressure monitoring module, and for any surrounding

Alarm	Display Mode	Solution
	2. The tire pressure value displayed is: Abnormal signal	electromagnetic source nearby.
System failure	1. The tire pressure fault warning light flashes and then is steady on. 2. Message prompt: Check tire pressure monitoring system 3. The tire pressure value displayed is: Abnormal signal	Check the tire pressure monitoring module and tire pressure control module, or change them if necessary.

Precautions

- The running time of the tire pressure monitoring module is related to the daily travel distance and other factors.
- The monitoring module regularly transmits tire pressure and other information to the display. Therefore, if the tire pressure drops suddenly or there is a flat tire, the monitoring module will not transmit data to the display until the next monitoring. In this case, the vehicle may be out of control. If there is a flat tire and monitoring fails to inform, or if you feel that there are some tire problems, stop driving immediately instead of waiting for the display to signal an alarm.
- Incorrectly installed monitoring module affects the air tightness of the tire. It is recommended that the installation and replacement of the pressure monitoring module be carried out by professional technicians of a BYD authorized dealer or service provider in accordance with the requirements of the installation manual.
- To change tire position or replace tire pressure monitoring module, first

rematch the entire tire monitoring system. It is recommended to have this done by the professional technicians from a BYD authorized dealer or service provider; otherwise, system failure may occur.

- Since tire pressure varies with regional temperatures, inflate or deflate the tires according to the values displayed on the instrument cluster and the standard tire pressure values.
- TPMS applies wireless transmission, which may lead to poor reception under serious interference.

WARNING

- The system does not stop vehicle traveling in the event of abnormal tire pressure. Therefore, each time before driving, ensure that the tire pressure conforms to the requirements specified by the manufacturer. If not, do not drive, otherwise vehicle damage or personal injury can occur.
- If pressure is found to be abnormal while driving, check the tire pressure immediately. If

WARNING

the low pressure warning light comes on, avoid sharp turns or emergency braking, and reduce vehicle speed, pull it over to the curb and stop as soon as possible. Driving with low tire pressure can cause permanent damage to tires and increase the likelihood of tire scrapping. Serious tire damage can lead to traffic accidents, resulting in serious injuries or deaths.

Acoustic Vehicle Alerting System (AVAS)

Acoustic Vehicle Alerting System (AVAS) refers to the broadcast to pedestrians near the vehicle when it is traveling at low speed.

- When driving forward:
 - The broadcast volume increases with the increase of vehicle speed in the range of $0 \text{ km/h} < V \leq 20 \text{ km/h}$.
 - The broadcast volume decreases with the increase of vehicle speed in the range of $20 \text{ km/h} < V \leq 30 \text{ km/h}$.
 - At speeds above 30 km/h , the broadcast sound stops automatically.
- The vehicle makes a continuous and balanced prompt sound when moving in Reverse.
- AVAS has two sound sources: standard and brand. To choose a sound source, go to  → **Vehicle** → **Notifications**.

WARNING

- If the AVAS prompt sound cannot be heard when driving at a low speed, stop the vehicle in a relatively safe and quiet place,

WARNING

open a window, then drive at a constant speed of 20 km/h in D gear and check whether an audio prompt can be heard from the front of the vehicle. If it is confirmed that there is no sound, contact a BYD authorized dealer or service provider to deal with it.

Panoramic View*

To enable the panoramic view, tap **Vehicle View** on the infotainment system homepage, press the button on the steering wheel or shift into Reverse.



- Landscape mode:
 - On the bottom of the infotainment touchscreen, tap the icon for front, rear, right, or left view. View of the selected area is displayed in the image section.



- In the single front and rear views, double-tap the image section

to switch to a 180° perspective displayed in full screen.

- Tap the radar icon  in the panoramic view to enable the radar display, and tap it again to disable it. When the radar display is enabled, a warning is displayed as the vehicle is approaching an obstacle.
- Portrait mode:
 - On the bottom of the infotainment touchscreen, tap any two of the icons for front, rear, right and left views. Views of the two selected areas are displayed in the image section.
- Slowly tap the vehicle image on the left to switch between transparent and non-transparent vehicle images.



- After the vehicle starts, the image before last power-off is displayed on the transparent panoramic view screen. Foreign bodies shown may be inconsistent with the actual ones in the underbody and surrounding blind areas. The underbody image update will begin only after the vehicle has started to run and will be complete when the vehicle has been driven beyond its length.

WARNING

- This system uses wide-angle fisheye cameras, so the object on the display screen may appear somewhat deformed in

WARNING

- comparison with the actual object.
- The panoramic view system is only to be used for parking/driving assistance. It is not safe to rely solely on this system to park or drive the vehicle, because there are some blind spots in front of and behind the vehicle. The surroundings of the vehicle should be observed in other ways during the parking/driving process, so as to avoid accidents.
- When the side mirrors are not extended in place, do not use the panoramic view system; and when the panoramic view system is used for parking/driving, ensure that all the car doors are closed.
- The distance to an object displayed on the panoramic view screen may be different from the distance perceived subjectively, especially when the object is closer to the vehicle. Assess the distance in various ways.
- Cameras are installed above the front bumper, the lower parts of the side mirrors, and the rear license plate. Make sure the cameras are unobstructed.
- To prevent affecting camera performance, avoid spraying directly on the cameras when washing the vehicle body with high-pressure water. Wipe any water or dust off the camera in time.
- Protect the cameras from any impact to prevent damage or malfunction.

WARNING

- After the vehicle is powered on, if you press the panoramic view start button or shift into reverse while the infotainment system is not fully activated, the output on the panoramic view screen will be delayed or the screen will flash. This is a normal part of the camera power-on process.
- When the vehicle runs at a low speed, the transparent panoramic view function is affected by speed fluctuation or multiple stops, so there will be misalignment between the images below the vehicle and that outside the vehicle.

Parking Assist System

- During vehicle parking, the parking assist system detects obstacles by sensors, and prompts the driver with the proximity of obstacles by an image on the infotainment touchscreen* and a speaker alarm.
- The parking assist system helps with reversing. Pay attention to the environment behind and around the vehicle during reversing.
- When you reverse the vehicle, a reversing image will be displayed on the infotainment touchscreen automatically.
- For your driving safety, when the reversing image is displayed, all buttons will be disabled except some volume and calls-related buttons.
- After reversing ends, the interface will be restored.

WARNING

- The parking assist system ceases to operate when the vehicle speed is over 10 km/h.
- Do not place any articles within the sensors' working range.
- To prevent sensor malfunction, do not wash the sensor area with water or steam.
- When no camera is available, a "No video signal detected" message is displayed.

Reversing Radar Power Switch

- You can enable or disable the reversing radar with the switch* or in  → **ADAS** → **Parking Assist** → **Reversing Radar**.
- When the ignition is switched on, the parking assist system is enabled automatically.

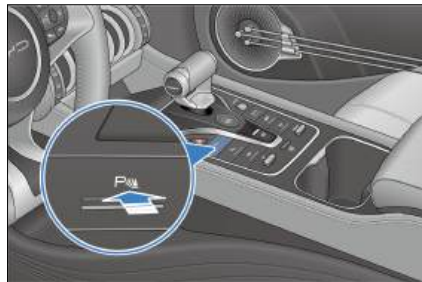

- When the parking assist system is enabled, the vehicle is not in "P", and the Electronic Parking Brake (EPB) and Auto Vehicle Hold(AVH) are released, the obstacle detection mode of the parking assist system is enabled. When enabled, the system raises an alarm if obstacles are found surrounding the vehicle; when disabled, it does not.

Sensor Type

- When the sensor detects an obstacle, the corresponding image is displayed on the infotainment touchscreen*, depending on the location of the obstacle and its distance from the vehicle.
- When the driver conducts parallel parking or reverse parking, the sensor measures the distance between the vehicle and the obstacle and communicates this information through the infotainment touchscreen and the speaker. Be aware of the surroundings when using this system.

- ① Front left sensor*
- ② Front right sensor*
- ③ Rear right sensor*
- ④⑤ Rear middle sensors*
- ⑥ Rear left sensor*

⑥ Rear left sensor*



Distance Display and Speaker

When the sensor detects an obstacle, the location of the obstacle and its approximate distance from the vehicle are displayed on the infotainment touchscreen, and the speaker beeps.

Working example of center sensors

Approximate Distance (mm)	Touchscreen Display Example	Alarm Sound
About 700 to 1,200		Slow
About 400 to 700		Fast
About 200 to 400		Continuous

Working example of corner sensors

Approximate Distance (mm)	Touchscreen Display Example	Alarm Sound
About 400 to 600		Fast

Approximate Distance (mm)	Touchscreen Display Example	Alarm Sound
About 200 to 400		Continuous

CAUTION

- 0~200mm is the blind spot range of the system. For the poor detection accuracy and inaccurate alarm information, the alarm prompts in 0~200m are for reference only



Working Sensors and Detection Range

All sensors are activated upon reversing.

The illustration shows the sensors' detection range. Sensors have a range limitation, so drivers must check the surroundings before slowly reversing the vehicle.

- ① About 1,200 mm
- ② About 600 mm

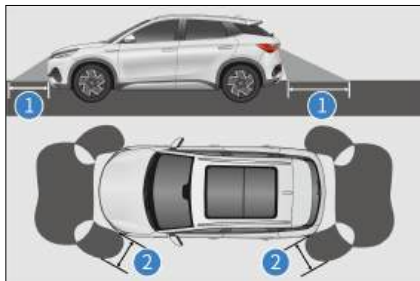

Error message

Failure of the parking radar system is indicated by a message on the instrument cluster and a beep.

REMINDER

- The parking assist system is only for assistance, and is not a substitute for personal judgment. Be sure to operate the vehicle based on your observations.
- Sensors will not work properly if accessories or other objects are placed within their detection range.
- In some cases, the system cannot operate properly and will fail to detect certain objects as the vehicle approaches them. Therefore, be sure to observe the vehicle's surroundings at all times. Do not rely solely upon the system.

Sensor Detection Information

- Certain vehicle conditions and surroundings may affect the sensors' ability to accurately detect obstacles. Detection accuracy may be affected if:
 - There is dirt, water or fog on the sensor.

- There is snow or frost on the sensor.
- The sensor is masked in any way.
- The vehicle leans significantly to one side or is overloaded.
- The vehicle is moving on particularly bumpy roads, slopes, gravel or grass.
- The sensor has been repainted.
- The vicinity is noisy due to honking of vehicles, motorcycle engines, air brakes of large vehicles, or other noises that produce ultrasonic waves.
- There's another vehicle with parking assist system nearby.
- The vehicle is fitted with a tow eye.
- The bumper or the sensor was hit hard.
- The vehicle is approaching a high or zigzag curb.
- The vehicle is driving in the sun or in the cold.
- The vehicle is fitted with non-original, lower suspension.
- Except as described above, sensors may not be able to correctly determine the actual distance due to the shape of the object.
- The shape and material of obstacles may prevent sensors from detecting them, especially the following:
 - Electric wires, fences, and ropes
 - Cotton, snow, and other materials that absorb radio waves
 - Any object with sharp edges and corners
 - Low obstacles
 - High obstacles facing outwards towards the vehicle
- Any object under the bumper
- Any object close to the vehicle
- Persons near the vehicle (depending on the type of clothing)
- If an image is displayed on the infotainment touchscreen* or there is a beep, it may be that the sensor detects an obstacle or is interfered. If the issue persists, go to a BYD authorized dealer or service provider for inspection.



CAUTION

- To prevent sensor malfunction, do not rinse or apply steam to the sensor area.

Driving Safety Systems

For better driving safety, the following driving safety systems works automatically based on driving conditions. However, these systems only provide assistance, and excessive reliance on them is not recommended.

Intelligent Power Braking System

- The intelligent power braking system is an advanced decoupled electrohydraulic brake system integrating vacuum booster, electronic vacuum pump, Antilock Braking System (ABS), Electronic Stability Controller(ESC) system and other features.
- The system assists vehicle braking according to the driver's demands and improves vehicle stability, comfort, and the recovery efficiency of brake energy.

Vehicle Dynamics Control(VDC)

When the vehicle turns suddenly while driving, if the vehicle swerves from the driver's normal lane, the VDC will correct

the situation by engaging brakes to the corresponding wheels to help the driver control skidding and maintain directional stability.

Traction Control System(TCS)

TCS prevents the drive wheels from skidding during acceleration by reducing the motor power, and, when necessary, applies braking forces to prevent drive wheels from spinning. It makes it easy for the vehicle to start, accelerate, and climb under adverse driving conditions.

WARNING

- TCS may not work effectively in the following situations:
 - On slippery roads, even if TCS is working properly, it may not be able to control the direction and meet power requirements.
 - Do not drive in conditions where the vehicle may lose its stability and power.

Hill Hold Control(HHC)

After the brake pedal is released, HHC maintains brake pressure for one second to prevent backward sliding.

Hydraulic Brake Assit(HBA)

When the brake pedal is pressed quickly, HBA recognizes that the vehicle is in emergency mode and actively improves the brake pressure. This allows ABS to intervene more quickly, effectively shortening the brake distance.

Controller Deceleration Parking(CDP)*

When you engage the EPB, the CDP function starts working so that the vehicle brakes at a constant deceleration (0.4 g if EPB is engaged but the brake pedal is not pressed, and 0.8 g if EPB is engaged and the brake pedal is pressed) until the

vehicle stops. The function stops working when the EPB is released.

Hill Descent Control(HDC)



Working principle: HDC is a value-added function of the ESC system to improve vehicle comfort, with the main purpose of assisting in downhill slow driving through active braking.

- To enable or disable HDC:
 - Enable or disable HDC in  → **ADAS** → **Active Safety** → **Hill Descent Control (HDC)**.
 - When the speed is below 38 km/h, you can also enable HDC by pressing the HDC switch. When the function is enabled, its status indicator on the instrument cluster is steady on.
- Press the HDC switch again to disable the function, and the indicator on the instrument cluster turns off. HDC also automatically stops when the speed exceeds about 65 km/h.
- When HDC is working, ABS is activated when the wheel slip exceeds the ABS triggering threshold, allowing you to safely and smoothly go downhill, or even reverse.
- HDC speed control:
 - HDC works at speeds between 11 km/h and 38 km/h, within which you can adjust the speed by pressing/ releasing the accelerator or brake pedal. The vehicle speed is set when the accelerator or brake pedal is released. The HDC status indicator flashes to indicate that the HDC is working.
- HDC malfunction:
 - In some special cases such as long downhill, the HDC function may be temporarily disabled due to the high temperature of the brake.

- A "Please check the HDC system" message is displayed for safety. To restore the function, stop the vehicle until the brake temperature cools down.

ESC operation instructions

Intelligent power braking system has the following new functions compared with the original ESC system:

- Brake assist mode
 - The brake assist mode is used to adjust the brake pedal feel. The relation curve between the brake pedal depth and the vehicle deceleration varies across different modes for the driver to choose their preferred pedal feel.
 - Adjust the brake pedal feel in  → **Vehicle** → **Intelligent Chassis** → **Brake Assist Mode**.
- Comfort parking
 - Comfort parking function: When the vehicle decelerates to stop in a non-emergency situation, the intelligent power braking system reduces the stop-instant suspension pitch and impact by controlling the brake pressure of the four brakes, providing a smooth stop feeling for the driver.
 - Enable or disable this function in  → **Vehicle** → **Intelligent Chassis** → **Comfort Parking**.
 - After the function is triggered, the braking distance may increase by 2-5 cm. Increase the distance from the vehicle or obstacle ahead accordingly before stopping your vehicle.
- Brake disc wiping
 - Brake disc wiping function: When the wiper switch is on, the intelligent power braking system applies a small brake pressure to all four brakes so that pads come into contact with discs to remove the water film from the discs. This shortens brake response time and braking distance.
- As long as the system detects rain or the wiper ON signal, the brake discs are repeatedly wiped at certain intervals to improve safety.
- ESC working
 - If there is a risk of skidding or backsliding when the vehicle starts on a slope, or if either drive wheel is spinning, the ESC indicator flashes to indicate that ESC system is working.
- Disabling ESC
 - If the vehicle gets stuck in snow or mud, ESC may reduce power output from the motor to the wheels, where the system should be turned off to get out of the jam.
- Turning off ESC
 - To turn off the ESC system, press the physical button or go to the infotainment touchscreen. ESC also checks its operating status in real time. If the ESC OFF switch is pressed while ESC is working, it completes the active intervention control this time rather than executes the "OFF" command immediately. ESC is disabled only after the intervention control is complete.
 - Some ESC functions may be re-enabled if you press the ESC OFF switch again or the vehicle speed exceeds the threshold of 80 km/h. ESC may be re-enabled only if the ESC is not in a vehicle dynamic intervention state.
- ESC OFF switch mis-operation*
 - ESC is considered to be mis-operated if the ESC OFF switch is pressed and held for more than 10 seconds. In that case, all internal ESC functions continue to work.

- Restarting ESC after the motor is powered off
 - When the ESC system has been turned off, restarting the motor will automatically restart ESC system.
- ESC start and speed linkage
 - Although already turned off, the ESC system can start on its own if the vehicle becomes extremely unstable as the speed increases and exceeds the threshold of 80 km/h.
- When ESC system is activated
 - If the ESC fault indicator  flashes, drive with caution.
- When ESC system is disabled
 - Be careful when ESC is disabled, and drive at speeds suitable for road conditions. The ESC system ensures vehicle stability and its driving force. Never turn it off unless necessary.
- Replacing tires
 - Make sure all tires are of the same size, brand, tread pattern, and total load. In addition, be sure to inflate tires to the recommended pressure.
 - Neither ABS nor ESC will work properly if the vehicle is fitted with different tires.
 - For details on tire or wheel replacement, it is recommended to contact a BYD authorized dealer or service provider.
- Tire and suspension handling
 - The use of any defective tire or modified suspension affects the driving safety system and may cause the system to fail.

Anti-lock Braking System (ABS)

- The ABS hydraulic system has two separate circuits. Each circuit runs diagonally through the vehicle (the left front wheel brake is connected to the right rear wheel brake). If one circuit fails, two wheels can still be braked.
- ABS helps maintain steering control by preventing the wheels from locking or skidding when brake is engaged suddenly or on slippery roads.

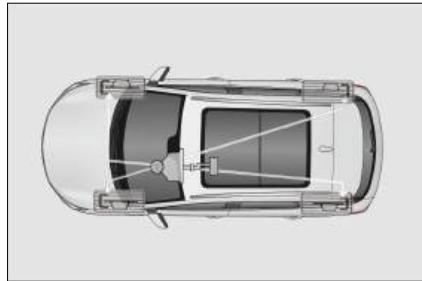

- When the front tires skid, there is no steering control, which means that the vehicle still moves forward even though the steering wheel is turned. ABS helps prevent locking and maintain steering control since pulsating prompt brake is much faster than human reaction.
- Never pulsate the brake pedal; otherwise, ABS may malfunction. While steering away from danger, a firm and steady pressure should always be maintained on the brake pedal for the ABS to work. This is what is sometimes referred to as "a firm step and a precise turn".
- When the ABS is working, the brake pedal will vibrate, which may produce noise. This is normal because the ABS is pulsating the brake quickly. How quickly ABS works depends on tire driving force (adhesion).

Important Safety Tips

- ABS does not reduce the time and distance required to stop the vehicle. It only helps control steering when braking. Please always keep a safe distance from other vehicles.
- ABS cannot prevent skidding caused by sudden direction change, such as trying to make a sharp turn or change lanes suddenly. Always drive carefully at a safe speed, regardless of road and weather conditions.
- ABS does not prevent decrease in stability either. When applying the brake in an emergency, the steering should be moderate. A large or sharp turn during the driving can cause the vehicle to swerve into oncoming traffic or run off the road.
- When running on soft or uneven surfaces (such as gravel or snow), a vehicle with ABS may require a longer braking distance than a vehicle without ABS. In such cases, reduce the vehicle speed and keep a greater distance from other vehicles.

WARNING

- ABS cannot work effectively under the following conditions:
 - Tires with inadequate grip are used (for example, excessively worn tires used on snow-covered roads).
 - The vehicle skids when driving at a high speed on slippery roads.

CAUTION

- If the ABS warning light is still on while the brake system warning light turns on, stop the vehicle in a safe place immediately and contact a BYD authorized dealer or service provider

CAUTION

- ABS cannot prevent skidding caused by sudden direction change, such as trying to make a sharp turn or change lanes suddenly. Always drive carefully at a safe speed, regardless of road and weather conditions.
- ABS does not prevent decrease in stability either. When applying the brake in an emergency, the steering should be moderate. A large or sharp turn during the driving can cause the vehicle to swerve into oncoming traffic or run off the road.

0-100 km/h: Full Throttle Experience

Full throttle can be achieved when:

- The high-voltage battery SOC is 95% or higher.
- The vehicle is in SPORT mode.
- The acceleration timer page is displayed in the menu.

WARNING

- Please be mindful of all relevant safety measures when experiencing this function.
- Before experiencing this function, check if the tire, brake and other vehicle functions are in optimal conditions.
- Do not use this function when visibility is low (e.g. dust, haze and night).
- Do not use this function on slippery, snowy, muddy, or water-

! WARNING

logged roads, nor on grass, sand, etc.

- Do not use this function on roads with complex traffic environments (e.g. at junctions, with pedestrians or other traffic participants).
- Do not use this function before you are fully familiar with the vehicle, so as to avoid accidents caused by incorrect operation.

Other Main Functions

Interior Rearview Mirror

Automatic Anti-glare Interior Rearview Mirror*

The automatic anti-glare interior rearview mirror is equipped with electronic anti-glare function, which automatically adjusts the lens color of the mirror according to the surroundings to reduce the interference of rear glare on the driver's field of vision.



! WARNING

- Do not hang heavy objects from the interior rearview mirror, or shake or drag it with force.
- When manually adjusting the interior rearview mirror, do not forcibly adjust the stuck mirror to avoid the mirror falling off.
- Adjusting the interior rearview mirror before driving. Do not adjust the rearview mirror while the vehicle is in motion, as it may distract the driver's attention, causing personal injury or death from accidents.

Manual Anti-glare Interior Rearview Mirror*

- Normal mode: Rotate the control stick left to get the clearest mirror image.
- Anti-glare mode: Rotate the control stick right to effectively reduce interference from rear vehicle headlights. Note that anti-glare may lower the clarity of rear visual field.

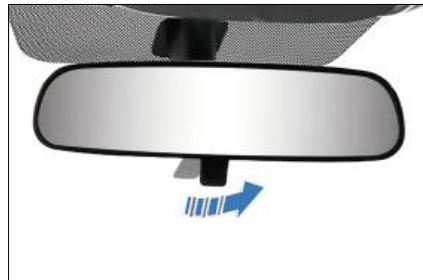

Power Side Mirrors



Side Mirror Switches

Folding side mirrors manually

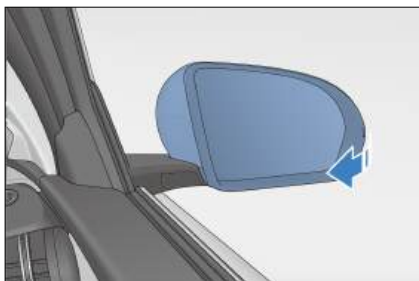

Push the outer edge of a side mirror to rotate it around the folding axis to the locked position.

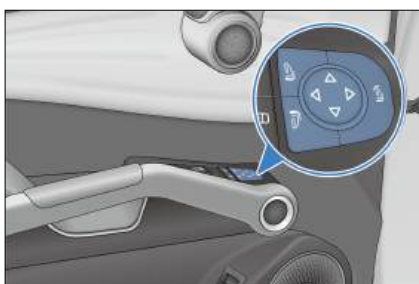

Folding side mirrors with power

- 
 Press the fold button to fold both left and right side mirrors, which will return to their pre-folding positions if this button is pressed again.
- 
 The left side mirror can be selected by pressing the corresponding auto regulation switch .







- Side mirror auto-fold can be controlled by tapping  → **Vehicle** → **Exterior Rearview Mirror** → **Auto-fold**.
- 
 The right side mirror can be selected by pressing the corresponding auto regulation switch .
- 
 There are four directions (i.e. up, down, left and right) for regulating lens

directions to adjust the side mirrors.

! REMINDER

- If the side mirrors get frozen, do not operate the controller or scrape their surface. Deicing spray should be used.
- Adjusting side mirrors before driving. Do not adjust the side mirrors while driving. This may distract your attention, causing accidents.

Wipers

- The lever is used to control the windshield wipers and washer. It has five modes:
 -  : Fast
 -  : Slow
 -  : Intermittent
 -  : Off
 -  : Point-wiping

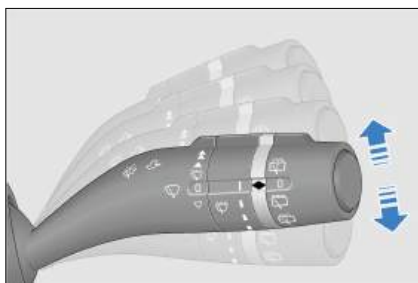

- Push up or pull down the lever to select a mode.
- In slow and fast modes, the wiper operates continuously.

- Pulling down the lever from the 0 position activates the point-wiping mode ▽. The wipers wipe at a low speed until you release the lever.
- The INT knob determines the frequency at which the intermittent mode wipes.

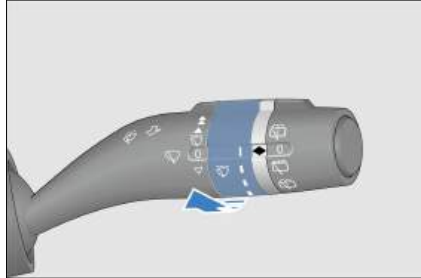
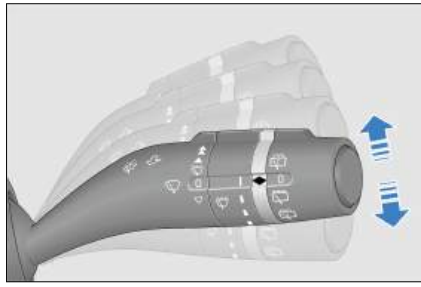
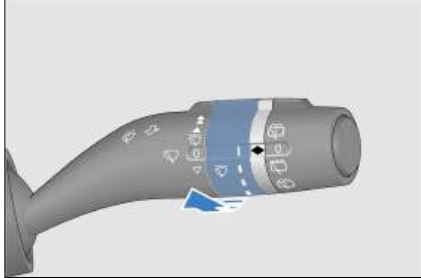

Front windshield washer 

- To clean the front windshield, pull the switch lever backward (towards the steering wheel) so that the washer sprays washing fluid while the wipers operate.
- The washer spray will stop when the stick is released, or when it is held for over 10 seconds. The wipers will operate once or twice further after the spray has stopped, and once more after five seconds to remove excess water.

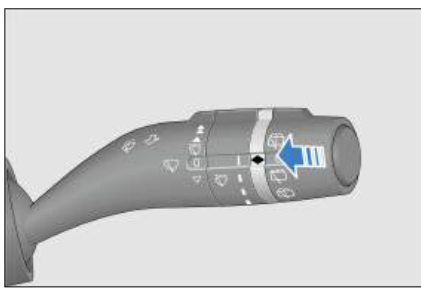
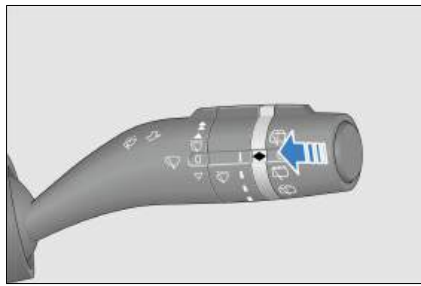

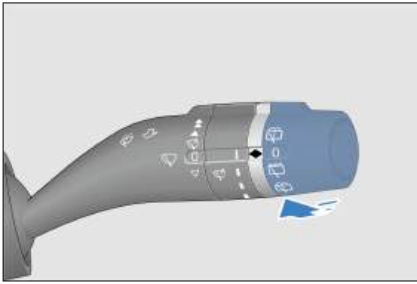

Rear Windshield Wipers and Washer

- Set the wiper switch to  to activate the rear windshield wiper; set it to 0 or open the trunk to stop the wiper.

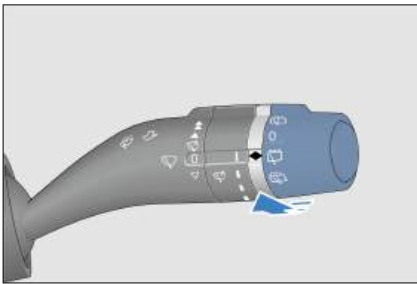

- Set the wiper switch to  to activate the rear windshield wiper and washer simultaneously.



- Set the wiper switch to  and release it. The wiper will operate once or twice after washing fluid has been sprayed.

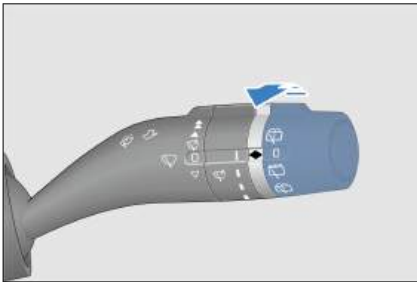

Link between rear wiper and trunk

- The wiper/washer won't work with the trunk opened and the vehicle powered on. If the wiper is working and the trunk is opened, it will stop and resume operation five seconds after the trunk is closed. If the front wiper is operating and the gear is shifted to "R",

the rear wiper will be automatically activated.

CAUTION

- Do not operate the washer for over 10 seconds, or when the washer fluid tank is empty, as those may cause motor overheating or damage.

REMINDER

- Check and clean the wiper blades at regular intervals.
- Do not start the wipers while rain is starting, as the windshield cannot be cleaned and rainwater mixed with sand and dust may instantly blur your view, affecting driving safety.
- Use cleaning agent for glass. The use of water, or another type of detergent, may damage the washer motor.

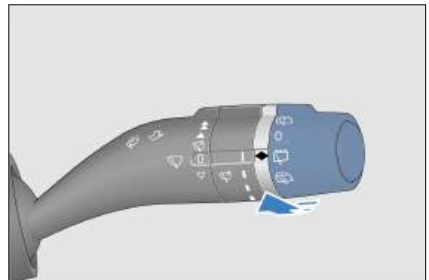
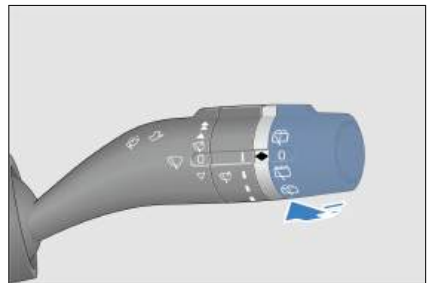

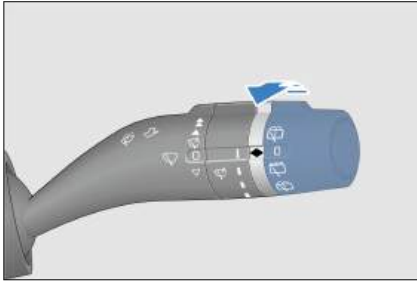

Replacing Wiper Blades

When the vehicle is powered on, enable or disable the front/rear wiper check on the infotainment touchscreen → **Car** → **Service** → **Overhaul**. When the corresponding wiper check function is enabled, the wipers rotate out automatically for easy maintenance and replacement.



Replacing front wipers

1. Pull up the wiper arm at the driver side, and then pull up the other at the passenger side.
2. Press the wiper lock button ①.
3. Hold the wiper blade and pull it out along the indicated direction ②.
4. When installing a new wiper blade, follow the reverse procedure.

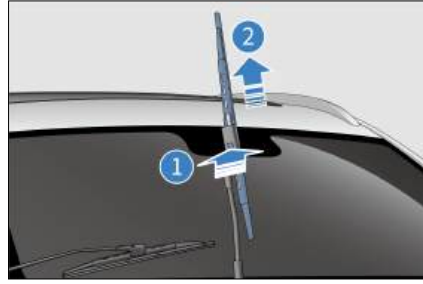

Replacing rear wiper

1. Pull up the wiper arm.
2. Hold the wiper in position ①, and pull the blade out vertically along the indicated direction ②.
3. When installing a new wiper blade, follow the reverse procedure.

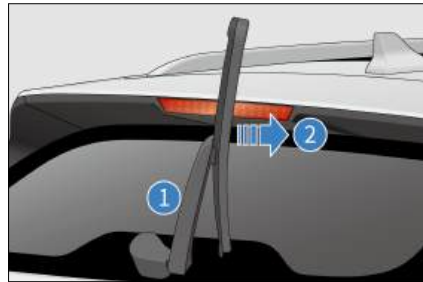

⚠ CAUTION

- Do not open the hood when the wiper arms are pulled up, as this may damage the hood and wiper arms.
- Lower the wipers slowly and avoid direct impact onto the windshield.
- Do not bend the wiper blade, and do not obstruct the wiper blade when the wiper is in operation.
- When replacing the wiper blade, after raising the wiper arm, hold it steady and gently lower it after replacing the wiper blade.



CAUTION

Otherwise, before the wiper blade is installed, any external force could make the wiper arm snap back on the glass and risk breaking it.

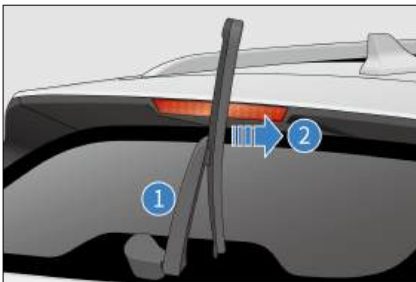
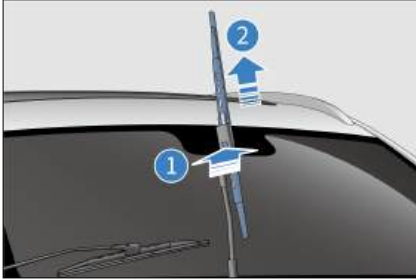

05

IN-VEHICLE DEVICES

Infotainment System.....	148
A/C System.....	154
Storage Device.....	161
Other Devices.....	162

Infotainment System

Infotainment System

Infotainment Touchscreen

When the ignition is on, the initial screen is displayed for several seconds and the infotainment system starts to work. To better experience infotainment functions, such as apps and Internet calls, the system must be used after network connection.

A warning is displayed when the infotainment system starts for the first time. Tap **Agree** to enter the system.

You can use the customized infotainment touchscreen as needed. A shortcut menu is provided for your convenience, which can include WLAN, Bluetooth, mobile data connection, volume, light mode, and some other vehicle controls.

- ① Infotainment touchscreen
- ② Scroll button



- When the infotainment system is already started, press the button to turn audio off, press a second time to turn audio on. Press and hold the button for three seconds to restart the infotainment system.

- When the infotainment system is already started, scroll up to turn volume up or down to turn volume down. Volume ranges from 0 to 39. A mute icon is displayed when volume is 0.

Reset to factory settings

- This function factory resets the infotainment system.
 - During the process, do not touch any infotainment button or turn off the power supply, or errors may occur.
 - The process takes two to five minutes.

WARNING

- Do not use a high-power inverter in the vehicle, as this may cause infotainment system malfunction.
- Do not format or root the device, as this may cause infotainment system or vehicle malfunction.
- In driving, please use the infotainment system in landscape mode wherever possible for your safety.

CAUTION

- To prevent damage to the touchscreen:
 - Touch the screen gently. If there is no response, remove fingers from the screen, then touch it again.
 - Clean the screen with a soft damp cloth. Do not use any cleaning product.
- Using the touchscreen
 - When the screen temperature is low, the image displayed may be

**CAUTION**

darker or the system may work slightly slower than normal.

- The screen may be dark or difficult to see when you are wearing sunglasses. In that case, change the viewing angle or take off the sunglasses.
- Touchscreen buttons that are grayed out cannot be operated.
- The touchscreen interface shown here is for reference only.
- It is recommended to contact a BYD authorized dealer or service provider in the event of a failure.

Navigation Bar

 : returns to the previous page or exits the program.

 : returns to the homepage.

 : shows recently opened applications.

 : switches between landscape and portrait touchscreen modes.

 : splits screen if applications support.

 : enables screen saver.

 : goes to vehicle setting screen.

- The customized map* allows for destination searching, route planning, navigation (online or offline), real-time traffic conditions, voice broadcast, and route recommendation. You can also add home, work and favorite destinations.
- Most interactive controls are on the left side of the map for searching for

charging piles, parking lots, and other interested places easily.

Gestures and Responses

Gestures and associated system responses are:

- Tapping: opens applications, selects functions, clicks icons on the touchscreen, or types characters.
- Dragging: touching and dragging an icon, thumbnail, or preview to the target position to change its location.
- Swiping: operational on homepage and app screens.
- Double-tapping: zooms in or out an image and double tap to get back.
- Spreading/pinching: zooms in or out an image with two fingers.

OTA Upgrade*

- The vehicle software can be upgraded. You can go to the infotainment touchscreen →  → **System** → **Version** → **Software Version** → **Upgrade** to upgrade the vehicle system and get the latest vehicle functions.
- When a vehicle software needs to be updated, there will be a prompt message. You can upgrade it immediately, schedule an upgrade, or upgrade it by mobile phone according to your use of the vehicle.

**CAUTION**

- Do not move the vehicle during the OTA upgrade.
- Before the OTA upgrade, make sure the vehicle is parked in a safe area with the gear in "P", and the



CAUTION

mobile communication network connection is normal.

- Make sure your vehicle is fully charged before the OTA upgrade.
- Do not install any third-party devices at the vehicle's OBD port before or during the OTA upgrade.
- The vehicle cannot be charged or discharged during an upgrade. Make sure your vehicle is fully charged before the upgrade.
- During the OTA upgrade, all functions are not available except the smart key/microswitch unlocking/locking, interior light switch, hazard warning light, and window switches.
- If the OTA upgrade fails, try it again. If it also fails, contact a BYD authorized dealer or service provider for handling.

BYD Assistant

BYD Assistant is an intelligent voice assistant that responds to your voice commands, such as requesting navigation, playing music/radio, making a phone call, and controlling in-vehicle devices.

- Waking up BYD Assistant:
 - On the steering wheel, press the  button.
 - On the infotainment touchscreen, tap .
 - Say the wake-up word: Hi, BYD.
- Your voice commands can be recognized after system wake-up.
- Give any instructions.

- This may be "Go home" (shortcut locations set), "Play music", "Make a call" (contacts data and Bluetooth connection required), "Set the temperature to 23°C", or "Turn on the seat ventilation for the driver". BYD Assistant then performs the recognized instruction.



Bluetooth Call

Connection

1. On Bluetooth Call screen, tap **Please connect Bluetooth** to establish connection.
2. Tap **Scan for device** to search for available devices.
3. Pair the available device, and make sure the pairing code displayed on your phone is consistent with the code on the touchscreen.
4. Set Bluetooth when connection is complete.

Bluetooth Call

Go to the dialing screen when Bluetooth is connected.

- Tap **Contacts**, **Call log**, and **Missed calls**, or use dial keypad to make a call.
- Tap  to zoom in or out the dialing screen.
- Tap  to display or hide the dial keypad.
- In panoramic view screen, a small window pops up to inform driver of a call.

File Management

New folder

- Go to file management screen to create new folders. You can enter the

folder name, and tap **OK** or **Cancel** to perform actions.

- Tap the top of the file management screen to change file sources.

Search

- Tap **Search** on the upper left corner and enter file names to search for target files.

Cut / Copy

- Touch and hold any file, select target files and operation (Copy, Move and Delete), and then go to the edit status.

Rename

- Touch and hold any file, select Rename in dialog displayed, rename the selected file, and then tap **OK**.

Delete

- Touch and hold any file, select files, and then tap Delete.

Sort

- Files are sorted by name by default. You can also sort them by size, type, or time.

Attributes

- Touch and hold any file, select a file, and then tap **Details** to check its attributes.

BYD App

BYD App

- BYD app is a mobile application of Internet of Vehicle (IoV) developed by BYD independently. It allows you to control the vehicle remotely and check vehicle conditions, delivering cloud era experience of IoV.

- You can search for "BYD" in application markets such as Google Play and App Store to download and install BYD app.

Account Registration

App guidance and the following steps give instructions on signing up and logging in after BYD app installation.

1. Open the app, then tap **Sign up** to go to the registration screen.
2. Enter email address registered in BYD authorized dealer, tap **Send email** to receive verification code, and then enter the code in app.
3. Set your password in password setting screen to complete the registration, and then the homepage is displayed.



CAUTION

- Provide the email address registered at the BYD authorized dealer, or registration will fail.
- In the app, select a country or region on upper right corner of the screen. The default setting depends on your phone setting. If it is not where you make the purchase, choose the right one, otherwise your data will not be accessible.

Vehicle Condition and Control

The BYD App homepage provides information and control items of the vehicle.

1. The homepage shows remaining driving range, SOC, vehicle error information, and status of vehicle driving, charging, A/C system, seat heater, seat ventilator, and tire pressure.

2. Tap lock, unlock, light flashing & honking, or light flashing button to activate the corresponding function.
3. Turn on or off A/C on the app homepage, or tap the A/C card to perform other settings.
4. At the bottom of the homepage, tap the icon of seats, doors and windows, or tires to go to the associated screen and check their status.
5. If you have multiple vehicles on an account, tap the vehicle name in the upper left corner of the screen to switch between vehicles.

CAUTION

- The control function of the app is mainly for remote use. To use this function, ensure your phone and vehicle are connected to the Internet.

Individual Center and Vehicle Management

Tap the icon on the upper right corner to go to the individual center.

- **Vehicle management:** changes vehicle name and license plate number.
- **Account and security:** gets back or changes password.
- **Settings:** sets message reception, automatic login, and other items.
- **About:** includes privacy policy and information to contact us and give feedback.

NFC Digital Key*

- NFC digital key is a function provided by BYD for users. You can register mobile phones or wearable devices as vehicle keys to unlock, lock and start the vehicle.

- Before activating the NFC digital key, observe the following conditions:
 - The vehicle has been equipped with BYD Cloud Service.
 - The vehicle supports NFC digital key.
 - Some mobile phones and wearable devices support BYD NFC digital keys.

Activating the NFC digital key of mobile phone

Before activating, start the vehicle and shift into "P" with a valid smart key. There are three ways:

- Via BYD App:
 - Download BYD App in App Store, then register and log in to the app. Tap "Digital Key" and follow the instructions to activate it.
- Via email links:
 - Log in to the email account reserved when purchasing the vehicle on the phone, and activate the digital key according to the instructions in the email from bydapp@byd.auto.
- Via the infotainment touchscreen:
 - On the infotainment touchscreen, tap  → **Vehicle** → **Locks** → **Digital key** to activate the key according to the instructions.

Activating the NFC digital key of wearable device

Supported wearable devices include Apple Watch (consult a BYD authorized dealer or service provider for other supported wearable devices), and there are two ways for activating:

- Synchronize data to Apple Watch after the successful activation on iPhone:
 - Wear an unlocked Apple Watch and activate the iPhone digital key. After activation, iPhone synchronously prompts to add a digital key on the

nearby bound Apple Watch. Activate it according to the instructions.

- Via Watch App:
 - This method is applicable when the iPhone digital key is activated but not synchronized to the Apple Watch. Open the Watch on the iPhone, select "Wallet", find the corresponding key and tap "Add" to activate the key according to the instructions.

Using the NFC digital key

When using the NFC digital key, enable the NFC function of the mobile phone or wearable device. Usage:

- Carry a mobile phone or wearable device with a valid NFC digital key, put its NFC antenna area close to the NFC sign on the driver's side mirror, and unlock or lock the vehicle. Consult the manufacturers for details of the NFC antenna area.
- Place the mobile phone or wearable device at the NFC sign in the vehicle to obtain the vehicle start permission.



CAUTION

- With permission, start the vehicle as soon as possible. If the vehicle is not started in time, place the mobile phone or wearable device at the NFC sign again to obtain the permission.

Removing the NFC digital key

There are three ways:

- Via BYD App:
 - Open BYD App, enter the digital key management page, tap the key to be removed, and enter the operation password to remove it.
- Via the infotainment touchscreen:

- With a valid smart key, go to the infotainment touchscreen → → **Vehicle** → **Locks** → **Digital key** to remove the key according to the instructions.

- Via Wallet:
 - Open the Wallet on the phone, select the digital key, and remove it according to the instructions.

Mobile Phone Bluetooth Digital Key*

Mobile phone Bluetooth digital key

You can use the key to control the vehicle through a close-range mobile phone Bluetooth connection, including locking or unlocking the doors.

- You can download and install the latest BYD App in the app market. The function of Bluetooth digital key can be found in the app.
- With vehicles supporting Bluetooth digital key, you can use the key after activating it in the BYD App.
- Turn on the Bluetooth on your phone, approach the vehicle, and open the BYD App for automatic Bluetooth digital key connection. You can also connect it manually. The key is effective after Bluetooth is connected.
- The specific functions supported by the key are subject to the vehicle configuration. The key can be used without network. After the key connection, you can select operations, and the app will immediately send commands to control the vehicle.
- In some countries and regions, according to relevant regulations, when a user starts the vehicle, the vehicle will detect the position. The vehicle can be started only when it detects that the Bluetooth digital key is within two meters of it to ensure the vehicle property safety.

CAUTION

- Before activating the Bluetooth key, ensure that the vehicle network signal is good. If the activation fails, try to move the vehicle to a place with good network and activate the key again in the application.
- After the vehicle is unlocked with a Bluetooth digital key, the doors will lock automatically if there is no operation in a short time.
- When the Bluetooth key connection or operation fails for many times, you can turn the Bluetooth off and then on, or restart the application.
- Limited by the vehicle environment and mobile phone performance, the effective distance of the key will be reduced in case of dense vehicles.
- There are a few mobile phones that are not compatible with Bluetooth digital keys.

A/C System

A/C Panel

Front A/C buttons:

- ① AUTO
- ② A/C ON/OFF
- ③ Front windshield defroster

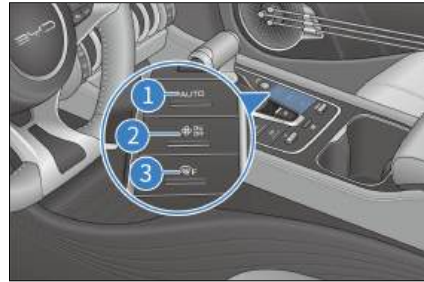

A/C Operation Interface

- To access the A/C setting interface, go to  → **Vehicle** → **A/C**.

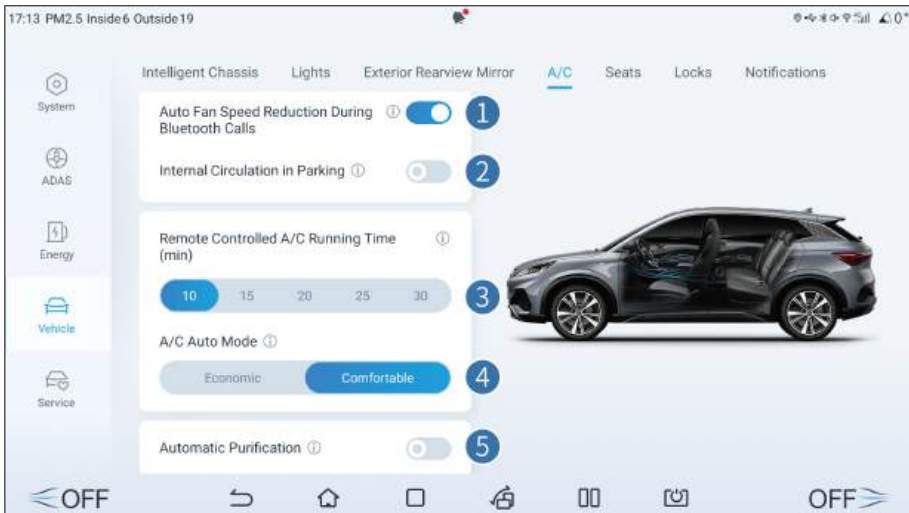

① Auto fan speed reduction during Bluetooth calls

- Tap this button to enable this setting.
- Tap this button a second time to disable it.

② Internal circulation in parking

- Tap this button to enable this setting.
- Tap this button a second time to disable it.

③ Remote controlled A/C running time (min)

- Tap this button to set the time for remote A/C running.

④ A/C auto mode*

- Two options are available: Economical and Comfort.

⑤ Automatic purification*

- Tap this button to enable auto purification function.
- Tap this button a second time to disable it.

Front A/C Operation Interface



- | | | | |
|---|-------------------------------|----|---|
| 1 | A/C operation interface | 9 | Front windshield defroster |
| 2 | Seat heating and ventilation* | 10 | Defroster for rear windshield & side mirrors* |
| 3 | Air purification system* | 11 | Circulation mode |
| 4 | A/C settings | 12 | Ventilator |
| 5 | A/C ON/OFF | 13 | Driver's temperature control |
| 6 | Auto mode | 14 | Air distribution |
| 7 | Cooling | 15 | Fan speed control |
| 8 | Max cooling | | |

Function Definition

Auto mode

- After tapping this button, its indicator lights up on the front A/C panel, and compressor status, fan speed and air distribution can be adjusted automatically.
- The vehicle exits auto control if fan speed or air distribution is set, and other functions remain in auto mode except for those that have been operated.

A/C ON/OFF

- Tap this button to disable the A/C if it is ON.
- Tap this button to enable the A/C if it is OFF.

Max cooling

- Tap this button to switch the A/C to the maximum cooling control mode. The temperature is set to "Lo", the fan speed is set to the maximum, the recirculation mode is activated, and air is directed to face level.
- Tap this button again to exit.

Cooling

- Tap this button to activate the A/C compressor. The compressor then starts to work for cooling.
- Tap this button again to deactivate the function, and the compressor stops working.

Circulation mode

- Tap this button to switch to recirculation mode. Tap it again to switch to fresh air mode.

- When the "auto air recirculation" function is enabled, to ensure air quality in the vehicle and prevent the vehicle exhaust from entering the vehicle, the recirculation mode is switched on automatically after you shift into "P".

Ventilator

- Tap this button to activate A/C ventilation control. The outlet air is natural air.
- Tap this button again to exit.

Temperature controls

- A/C temperature regulation
 - Tap the upside arrow or slide it down to increase the temperature. Tap the downside arrow or slide it up to lower the temperature.
 - When the temperature is set to the lowest, "Lo" is displayed. When it is set to the highest, "Hi" is displayed.

Front windshield defroster

- Tap this button to enter the front windshield defrost mode, distributing air to the front windshield, The corresponding indicator on the front A/C panel lights up.
- Tap this button again to deactivate and exit the front windshield defroster control mode. The corresponding indicator on the front A/C panel turns off.

Defroster for rear windshield & side mirrors*

- Tap this button, and the heating panel in side mirrors will quickly clear the side mirrors. The function is automatically deactivated after 15-

minute inactivity of the associated button.

- Tap this button a second time to disable the function.
- This function is not for drying raindrops or melting snow.

REMINDER

- Using the side mirror electric heating defrosting function for a long time may cause the mirror to wear out faster. Turn off the defrost button when it is not needed.

Fan speed control

- Tap the chosen position. The more bars illuminated, the faster the fan speed.

Air distribution

- Tap an icon on the infotainment touchscreen to select the corresponding air distribution mode.
- You can turn on multiple air distribution modes at a time (up to three).
- Adjustments can be made according to the air supply illustration.

Blowing face  : Air flows to the face level.

Blowing legs  : Air flows to the leg level.

Defrost  : Air flows to the front windshield and side windows.



Usage Precautions

- To quickly cool down the interior after long exposure to sunlight, drive for a few minutes with the windows open to exhaust hot air and speed up A/C cooling.
- To speed up cooling, adjust the temperature to "Lo" and use the recirculation mode for a few minutes.
- Make sure that the air intake grille in front of the windshield is not blocked (for example, leaves or snow).
- Avoid blowing cool air onto the windshield in humid weather. The inner and outer temperature difference can cause glass fogging.
- Keep the space under the front seats clear to improve air circulation.
- In cold weather, run the fan at high speed for one minute to remove snow or moisture from the intake passage and reduce fogging.
- Use recirculation mode for a few minutes for quick heating in cold weather, and switch to fresh air mode to prevent fogging after cabin is heated up.
- In dusty or windy driving conditions, close all windows, switch on the recirculation mode, and turn on the A/C.
- In heating mode, press the compressor control button to light up the button

(turning on the compressor), which can reduce airflow moisture.

- In the ventilation mode, the system introduces the natural wind from outside, which is suitable for spring and autumn.

REMINDER

- A/C odor:
 - It is normal that there may be a damp and moldy smell just after the A/C is turned on. During the operation of the automobile A/C, A/C condensation often remains in the evaporator, and the wet evaporator can easily absorb dust, sweat, smokes, and other odors inside the vehicle. Condensation not blown dry promotes mold growth on the sunless and damp evaporator surface, which is very likely to produce unpleasant odors with fermentation over time.
- How to prevent A/C odors:
 - Turn off the A/C and ventilate with natural air before parking to keep the air inside the vehicle relatively dry.
 - Inspect, clean, or replace the A/C filter regularly.
 - Try to keep the cabin clean and fresh.
- If the odor persists after odor prevention methods are used, it is recommended to contact a BYD authorized dealer or service provider for repair.
- In order to reduce odors from the A/C, if the A/C is already turned on, the A/C blower may keep running for a while after the vehicle is powered off and locked. That is because the condensed

REMINDER

water on the surface of the evaporator needs to be dried to prevent mold fermentation. It is normal for the A/C blower to start running automatically when you lock the vehicle. No need to worry about it.

Vents

Front Center Vent

- Move the knob to adjust airflow or to open/close the vent.
- Toggle left/right to adjust airflow direction.

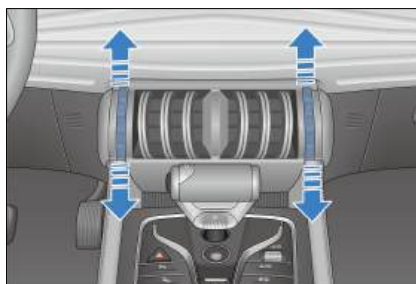

Front Side Vents

- Move the knob to adjust airflow or to open/close the vent.
- Toggle left/right to adjust airflow direction.

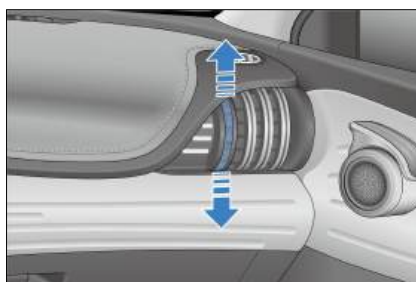

Rear Side Vents

- Move the knob to adjust airflow or to open/close the vent.
- Toggle left/right to adjust airflow direction.

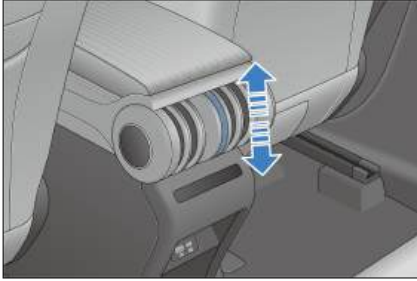

Air Purification System*

The air purification system purifies airborne PM2.5 particles. When A/C is turned on, the system thoroughly removes PM2.5 particles from the air blown into the cabin.

Quick Purification Button

- This function can quickly reduce the concentration of PM2.5 particles in the air inside the compartment in a short time.
- Tap on this button to activate and enable the function; and tap on the button again to exit.

PM2.5 Detection Button

- Tap on the "PM2.5 detection" button to activate and detect PM2.5 concentration inside/outside in realtime, which will be displayed in real time on the infotainment touchscreen.
- PM2.5 detection will stop if the button is tapped on again.

Air Purification Operation Interface

Tap **Air purification** on the infotainment touchscreen, the air purification interface is displayed.



- 1 Air purification button
- 2 Outside PM2.5 value and level
- 3 PM2.5 detection
- 4 Purification
- 5 Inside PM2.5 value and level

Inside PM2.5 value and level

- Displays the PM2.5 value and level outside/inside the vehicle.
- The Particulate Matter 2.5 (PM2.5) value detected by the on-board air purification (PM2.5) detector is the

PM2.5 value in the air near the vehicle carrying the device in a short time, which should be different from the daily or real-time PM2.5 value declared by national and relevant government authorities.

Here is a reference of air quality grade:

Range of PM2.5 Values	Air Quality Grade
0-35	Good
36-75	Moderate
76-115	Detrimental to sensitive groups
116-150	Unhealthy
151-250	Very unhealthy
251-999	Hazardous

! REMINDER

- The frequency of PM2.5 detection should be reduced in the following environments:
 - Sandstorms and other such extremely harsh environments.
 - Cold regions (with ambient temperature below -20°C).
 - High humidity environments (relative humidity >90%).
 - Environments with a change in temperature (prone to condensation), such as driving in from a cold environment to a high-temperature indoor environment or parking lot.
- Running maximum air flow speed in internal circulation mode can

! REMINDER

quickly reduce the concentration of fine particles in the air inside the vehicle.

Switching on A/C with Cloud Service App

Tap the A/C card on the BYD app homepage to access the A/C control screen, where you can regulate A/C temperature, set duration, and preset A/C.

- Tap on the plus sign (+) or minus sign (-) to regulate A/C temperature. You can also set rapid heating or rapid cooling.

- Tap **More settings** to set duration and circulation mode.
- Tap **Preset** to set the A/C starting time in the next 24 hours.

Storage Device

Door Bins

- There is a door bin on each door for storage of beverage bottles or small items.

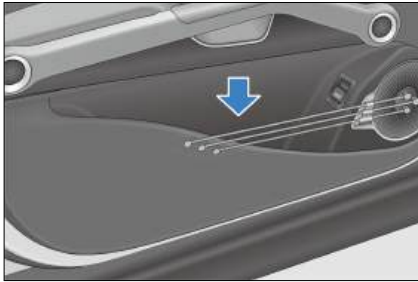

Glove Box

- Pull the handle to open the glove box.
- Push the lid up to close it.

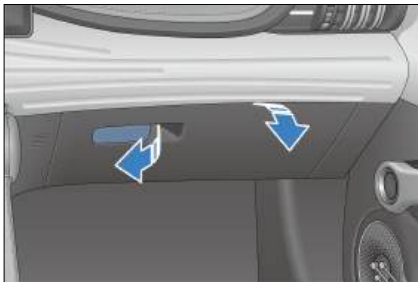

! REMINDER

- To reduce risk of injury in the event of an accident or emergency

! REMINDER

braking, keep the glove box closed while driving.

Center Console Cubby

- Located between the front seats, open the cover to use.



Seatback Pockets

- There are seatback pockets at the back of the front seats for storing magazines, newspapers, or similar objects.

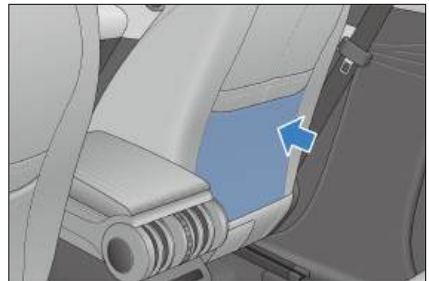

Cup Holder

- The front seat cup holder is located inside the center console cubby.

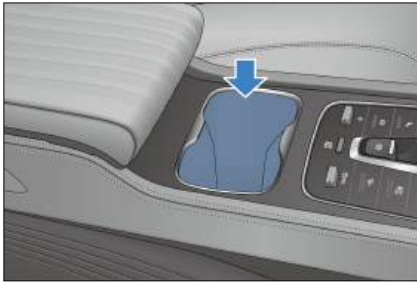

CAUTION

- When using the cup holder, do not start or brake the vehicle suddenly to prevent liquid spillage and burn you or other passengers.
- Do not place an open cup or untightened beverage bottle in the cup holder, so as to avoid liquid spillage while you are driving, opening or closing a door.
- To ensure safe driving, the driver is strictly prohibited from taking the cup out or placing it in the cup holder while driving.

Other Devices

Sun Visor

① Sun visor

- To block sunlight from the front, pull the sun visor down.
- To block sunlight from a side, remove the swivel sleeve from the fixed support and turn the visor towards the side window.

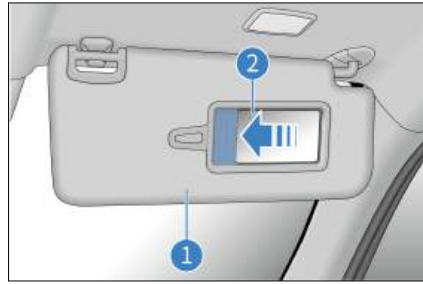

② Vanity mirror

- Flip down the sun visor and slide the mirror cover for use.

REMINDER

- Correct use of the sun visor improves driving safety and comfort.

Grab Handles

- Pull the grab handle down for use. The handle returns to its original position when released.

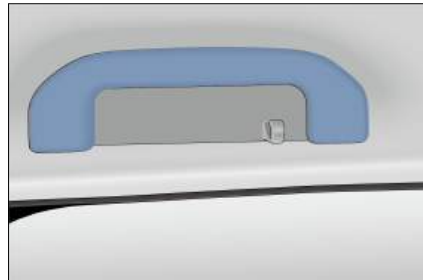

CAUTION

- Do not hang any heavy objects from the grab handles.

USB Ports

Front-Row USB Ports

There are two ports installed in the lower layer of the auxiliary console.

- ① Type-A port for data transfer.
- ② Type-C port, which can be used only for charging.

The power outlet can be used only when the ignition is on.

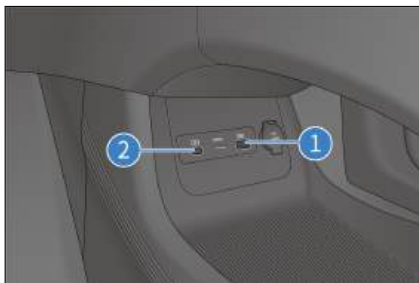

Rear-Row USB Ports

- These ports are for charging only and cannot be used for access to the infotainment system.
- The power outlet can be used only when the ignition is on.

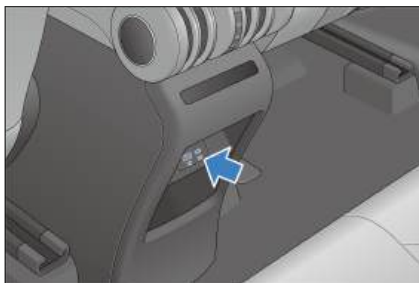

- The infotainment system is compatible with USB storage devices up to 128GB. It is not compatible with some USB devices on the market.

- It is recommended to use USB storage devices up to 128GB with FAT32 format.

CAUTION

- Do not use substandard or special USB storage devices to avoid damaging the infotainment system or data in the USB device.

12V Auxiliary Power

- It is used for accessories with 12V DC working voltage and no more than 10A working current.
- The 12V auxiliary power is available only when the ignition has been switched on. Lift the cover to use it.



Wireless Phone Charger Location

- The charger charges phones without a cable connection through electromagnetic wave induction.
- On the infotainment touchscreen, slide down the shortcut menu and light up the wireless charger icon .
- After starting the vehicle, place a smartphone screen-up in the wireless charging area to activate the wireless charger.

- To disable the wireless charger: On the infotainment touchscreen, slide down shortcut menu and tap the wireless charger icon. The indicator turns off and the wireless charger function is disabled.

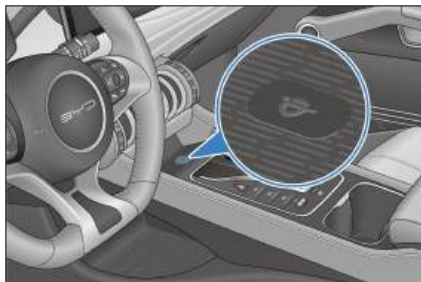

- The wireless phone charging function is not compatible with all smartphones, and only applies to Qi-certified phones.
- To avoid burning cards with chips, such as bank cards, do not place them between the wireless phone charging area and the phone during charging.

CAUTION

- Ensure your smart key is more than 25 cm away from the wireless charger area when the wireless charger system is working.
- To avoid wireless charger dysfunction or even accidents, do not place coins, metal keys, metal rings, or other articles containing metal in the wireless charger area together with the phone.
- To avoid damage to the charger area, do not place heavy objects on it. If the phone wireless charger system is faulty and does not work properly, it is recommended to contact a BYD authorized dealer or service provider.

CAUTION

- BYD will not assume any responsibility for any problems caused by improper use. If the product is disassembled or modified, the free warranty will be terminated.
- For safety reasons, do not leave an unattended phone being charged in the vehicle.
- For safety reasons, refrain from checking phone charging status while driving.
- If a metal item is found between the device and the charger rubber pad during charging, do not remove the metal item with bare hands to prevent burning.
- The center of the phone coil must be aligned with the center of wireless charger (indicated with text in the charging area), or charging may fail.
- Prevent any fluid from coming into contact with the charger area. The wireless charger will malfunction if water enters the wireless charger via the gap around the rubber mat.
- Charging may stop at high temperatures, and will resume once the temperature drops.
- BYD makes no commitments for problems caused by external wireless charging coils. Please use with caution.

REMINDER

- Only one phone can be charged at a time.

! REMINDER

- A phone case that is too thick may prevent charging.
- On bumpy roads, the wireless phone charging may intermittently stop and then resume.
- Place the mobile phone at the wireless charging area for charging. If the phone moves from the area and stops charging, move it back.
- If the phone cannot be charged properly, ensure that there are no foreign objects in the wireless charging area, or wait for the wireless charging area to cool down before trying again. If it is still impossible to charge the phone, contact a BYD authorized dealer or service provider.
- After power-off, if the phone is still at the wireless charging area and the driver's door is opened, the instrument cluster sounds an alarm and a warning text "Please take your cell phone with you" is displayed for five seconds.
- Phones must always be positioned horizontally in the charging area, whether for charging or not, otherwise gear shifting may be affected.



! WARNING

- When installing the cargo cover, make sure that it is installed securely.
- Do not place any objects on the cargo cover.
- Never allow a child to climb onto the cargo cover, otherwise, damage to the cargo cover, or even injury/death to the child, can happen.

Cargo Cover

- The cargo cover is used for privacy and direct sunlight protection.
- Snap the two grooved sides ① of the cargo cover into the lower C-pillar shield bosses on both sides, and then attach the cover drawstring ②.
- Do the reverse to remove the cover.

06

MAINTENANCE

Maintenance Information.....	168
Regular Maintenance.....	170
Self-Maintenance.....	174

Maintenance Information

Maintenance Cycle and Items

Maintenance Plan

- The maintenance plan is designed to ensure stable driving, failure reduction, safe and economical driving.
- The maintenance schedule lists all the maintenance items that are necessary to keep the vehicle in optimum condition at all times.
- The items in the maintenance schedule are important and need to be maintained according to the time interval.
- Hoses with any degradation or damage should be replaced immediately. Rubber hoses (for systems such as A/C, heating, and braking systems) must be checked by professional technicians according to the maintenance schedule.

Maintenance Schedule Requirements

The vehicle must be maintained according to the regular maintenance schedule.

If the vehicle is operated primarily under one or more of the following special conditions, certain maintenance items need to be performed more frequently.

- Road conditions
 - Muddy, sandy, or snowy roads.
 - Dusty roads
- Driving conditions
 - Use of towed trailer, camping trailer, or roof rack.
 - Within 8 km, repeated short distances are driven and the outside temperature is below freezing.
 - Long idling and/or long distance driving at low speed, for example, using the vehicle as a police car, taxis or using it for transporting goods.

Maintenance Schedule

Vehicle maintenance is performed based on the mileages or months, whichever comes first.

Item	Interval
Brake friction block and disc	Check every 24 months or 30,000 km
Brake piping and hoses	Check every 24 months or 30,000 km
Steering wheel and tie rod	Check every 24 months or 30,000 km
Drive shaft boot	Check every 24 months or 30,000 km
Ball pin and boot	Check every 24 months or 30,000 km

Item	Interval
Front and rear suspensions	Check every 24 months or 30,000 km
Tire condition and inflation pressure, incl. TPMS	Check every 24 months or 30,000 km
Tire wear (Check front and rear wheel alignment when tire uneven wear is greater than 2 mm)	Check during maintenance and rotate when necessary; Under severe working conditions, check more frequently and rotate when necessary
EPS corrosion and foreign materials on or ablation of connectors, including wiring harness GND point	Check every 24 months or 30,000 km
Coolant level in expansion tank	Check every 24 months or 30,000 km
Brake fluid	Check every 24 months or 30,000 km
Bumps or deformation of the high-voltage battery tray, crash bar, shield, and explosion-proof valve*, and powertrain leaks	Check every 24 months or 30,000 km
A/C filter*	Check every 24 months or 30,000 km. In severe driving conditions, check every six months and replace if necessary
Drive motor coolant	Replace the long-acting organic acid coolant every six years or 90,000 km
Brake fluid	Check during maintenance and replace every 24 months or 30,000 km
Gear oil in the transmission	Replace the gear oil and filter at 24 months or 30,000 km for the first time, and every 24 months or 48,000 km afterwards

Notes: When checking Item 1, replace chassis parts in a timely manner if any abnormal damage is found.



CAUTION

- Brake friction pads and discs need to be checked at different intervals and more frequently in severe weather conditions, such as extremely cold regions like Norway, Finland and Iceland.



REMINDER

- To keep the high-voltage battery in optimal condition, please fully charge and discharge the vehicle regularly (at least every six months or 72,000 km, whichever comes first) for battery self-calibration. You can also contact



REMINDER

a BYD authorized dealer or service provider for capacity testing and calibration.

Severe driving conditions refer to:

- Frequent driving in dusty areas or frequent exposure to salt-laden air.
- Frequent driving on bumpy, puddled, or mountain roads.
- Driving in cold weather.
- Frequent and sudden braking.
- Frequent use of a towed trailer.
- Use as a taxi.
- Driving in congested urban areas at temperatures above 32°C for more than 50% of total travel time.
- Driving at speeds over 120 km/h at temperatures above 30°C for more than 50% of total travel time.
- Frequent driving with full loads.

Smart Maintenance System*

- The vehicle is equipped with a maintenance system. Tap  → **Service** → **Maintenance** to set the maintenance interval and mileage.



Regular Maintenance

Regular Maintenance

- Be sure to maintain the vehicle as per the maintenance schedule to allow it serve in the best working efficiency and reduce fault occurrence.
- Drivers can refer to the maintenance plan for scheduled maintenance intervals, depending on the odometer reading or time interval, whichever comes first.
- For overdue maintenance items, the same time interval should be used for maintenance.
- It is recommended that maintenance be performed in accordance with the standards and specifications of BYD Auto Co., Ltd., and by a local BYD authorized dealer or service provider.
- The maintenance schedule lists the maintenance items and travel time or distance based on the assumption that the vehicle is used as a normal means of transportation to carry passengers and goods, so do not exceed the vehicle load limit.



CAUTION

- Please maintain the vehicle regularly according to the requirements in the Warranty and Maintenance Service Manual of BYD.

Vehicle Corrosion Prevention

The most common causes of vehicle corrosion are:

- The underbody of the vehicle is covered in salt, dust, or moisture.
- The vehicle or some of its parts are exposed to high humidity and high temperature for a long time.
- The paint layer or underlayer is scratched by minor collision or by stones and gravel.

The following rules should be observed to prevent vehicle corrosion:

- Wash the vehicle frequently.
 - If driving on saline roads in winter or living in coastal areas, wash the landing area of the vehicle at least once a month, and clean the chassis and hubcap with a high-pressure water jet or steam to reduce corrosion. Wash the chassis thoroughly after winter.
- Check vehicle paint and trims.
 - Any chip or crack found on the paint must be repaired immediately to prevent corrosion. If fragments or cracks peel off from the metal surface, it is recommended to go to a BYD authorized dealer or service provider for repair.
- Check cabin interior.
 - Moisture and dust buildup under the carpet can cause corrosion. Check the undersides of carpets frequently to make sure these areas are dry.
 - Special care should be taken when the vehicle is transporting chemicals, detergents, fertilizers, salt, and other substances. Such substances should be kept in appropriate containers for transportation. If spillage or leakage is found, clean immediately and keep dry.
- Use fenders.
 - Fenders protect vehicles in saline areas or on gravel roads. The bigger

and closer to the ground the fender, the better.

- Park in a well-ventilated and dry area.

Paint Maintenance Tips

- Do not perform secondary painting if there are no obvious scratches on the finish, so as to prevent mismatch or color incompatibility.
- When the vehicle is not used for a long period, it should be parked in a garage or a well-ventilated place, and special body cover should be used in winter. Choose a shady place for parking temporarily.
- Prevent strong impacts, knocks, or scratches on the paint. If the paint is scratched, dented or if it peels, it should be repaired in time, preferably by professional auto beauty provider.
- Do not touch the paint with a greasy hand or cloth. Do not place greasy tools or rub with organic solvents on the vehicle body so as to avoid chemical reactions.
- The vehicle must be waxed once a month or whenever water resistance performance of the vehicle degrades and be taken to an auto beauty provider for maintenance once every three months.
- High quality polish and wax must be used. If body finish is severely weathered, use a car cleaning polish in addition to the wax. Carefully follow the manufacturer's instructions and precautions. Chrome finish should be polished and waxed as well as painted finish.



CAUTION

- When the vehicle is repainted and placed in a high-temperature paint waxing workshop, the vehicle's plastic bumper must be removed to avoid damage caused by high temperatures.

Vehicle Cleaning

- The vehicle must be cleaned in time under the following circumstances, which can cause peeling of paint layer or corrosion of the vehicle body and parts:
 - Driving along the coast.
 - Driving on a road with antifreeze.
 - Driving on roads covered with coal tar.
 - Resin, bird droppings, or insect carcasses are stuck on the vehicle.
 - Driving in areas with a large amount of smoke, soot, dust, iron filings, or chemicals.
 - The vehicle is visibly soiled by dust or mud.
 - After raining.

Manual Vehicle Washing

Before washing the vehicle, park it in the shade, and wait for the vehicle to cool down sufficiently.

1. Hose off loose dirt, including all mud or road salts at the bottom of the vehicle and on wheel pits.
2. Wash the vehicle with neutral agents, the mixing of which should be carried out according to the manufacturer's instructions. Soak a soft cloth with cleaning solution and gently wipe it

down along the direction of the water flow. Do not wipe in a circular motion or horizontally.

3. Rinse well—Dried washing agent forms markings. After washing the vehicle in hot weather, rinse all parts properly.
4. Dry the vehicle with a clean soft towel to prevent stay water marks. In order to prevent scratching, do not rub or apply excessive force on the paint.



REMINDER

- Do not use any strongly alkaline washing powder, soapy water, detergents, de-waxing detergents or organic substance (gasoline, kerosene, volatile oil, or strong solvent) to clean the vehicle.
- When cleaning the combination lights, do not wipe their surface with chemical solvents such as gasoline, alcohol, lacquer thinner, thinner, and carbon tetrachloride. Doing so can cause the combination light casings to crack.
- It is recommended that vehicles traveling in coastal or heavily polluted areas be washed once a day.
- When washing the vehicle, make sure that the high-pressure water jets are at a sufficient distance from the vehicle, and do not aim them directly at the sealing strips, to prevent high pressure from distorting and even damaging the strips and water from leaking into the vehicle.
- Do not use blades or gasoline to remove hard dirt from the vehicle body. The plastic wheel trim is easily damaged by organic matter. If any organic matter splashes



REMINDER

on the vehicle trim, remove it with water and check whether the trim is damaged. Please replace any seriously damaged plastic wheel trim in a timely manner. Otherwise, the trim may fall from the wheel during vehicle movement and cause an accident.

- Do not use abrasive cleaning agents to scrub the bumper.
- Clean polished metal parts with carbon cleaner and wax them regularly for protection.

Automatic Vehicle Washing

When choosing an automated car wash service, be aware of certain types of brushes, unfiltered rinsing water, or machine-specific rinsing procedures that may scratch the paint and affect its gloss and durability, especially for darker colors. Before washing the vehicle, it is best to consult the staff of the car wash service provider to understand which washing procedures are the safest for the paint finish.

Interior Cleaning

Carpet

- Clean carpets with a good foam detergent.
- Use a vacuum cleaner to remove as much dust as possible. Several types of foam detergents can be used. Some are in spray cans, and the others are powders or liquids, which produce foam when mixed with water. Clean the carpets with foam soaked sponge or a brush, scrubbing in a circular motion.

- Do not use plain water, and keep the carpets as dry as possible.

Seat Belts

- The seat belts can be cleaned with neutral soapy water or lukewarm water.
- Scrub the seat belts with a sponge or soft cloth. Check the seat belts for excessive wear, tear, or cut marks.



CAUTION

- Do not clean the seat belt with colorant or bleach. These substances may decrease the seat belt's strength.
- Do not use any seat belt that is not dry.

Doors and Windows

- Doors and windows can be cleaned with any ordinary detergent.
- Check the door brakes regularly. If a door brake lever is found with visible dust accumulation, wipe it with a wet soft cloth.



CAUTION

- When cleaning the inside of the rear windows, take care not to scratch or damage electric heating wires or junctions.

A/C Control Panel, Car Speakers, Dashboard, Control Panel and Switches

- Clean the A/C control panel, car speakers, dashboard, control panel and switches with a wet soft cloth.
- Wipe dust off gently with a clean soft cloth soaked in lukewarm water.

 **CAUTION**

- Do not use organic substances (for example, solvents, kerosene, alcohol, and gasoline) or acid or alkali solutions. These chemicals can cause discoloration, staining, or flaking.
- Please confirm that the detergent or polishing agent to be used does not contain the above substances.
- If a new liquid washing agent is used, do not splash it onto the interior surface of the vehicle, because it may contain the above substances. If there is any spillage, immediately clean it thoroughly.

Leather

- Leather trimmings can be cleaned with a neutral detergent for woolen.
- Use a soft cloth with a neutral detergent solution to wipe off the dust, and then use a clean, wet cloth to wipe the remaining detergent thoroughly.
- If leather gets wet, wipe it with a clean soft cloth and air dry it in a cool, ventilated place.
- For any questions about vehicle cleaning, please consult a local BYD authorized dealer or service provider.

 **CAUTION**

- If dirt cannot be cleaned off using a neutral detergent, clean it with a detergent that does not contain organic solvents.
- Do not clean leather with any organic material such as volatile oil, alcohol, gasoline, acid or alkali, as these will cause discoloration.

 **CAUTION**

- Do not clean leather with a nylon brush or synthetic fiber cloth, as these may scratch the fine patterns on the leather surface.
- Mold may grow on dirty leather trimmings. Special care must be taken to avoid oil stains and trimmings must always be kept clean.
- Prolonged exposure to sunlight will cause leather to harden or shrink, so the vehicle should be parked in a shady and cool place, especially in the summer.
- In hot weather, avoid placing vinyl or waxy items on the trimmings, as these may stick to leather in high temperatures.
- Improper cleaning of leather trimmings may cause discoloration or spots.

 **REMINDER**

- Prevent direct water splash onto the dashboard or floor when washing the vehicle, as these may cause electrical faults.
- In order to prevent corrosion, do not wash the vehicle's floor.

Self-Maintenance

Self-Maintenance

Self-Maintenance Precautions

- If maintenance is to be carried out by the owner, be sure to follow the correct steps specified in this section.

- Note that improper and incomplete maintenance will affect the use of the vehicle.
- This section only lists instructions on simple maintenance items that can be done by the owner. However, there are many items that must be done by qualified technicians with special tools.
- Special care must be taken in maintaining vehicles to prevent accidental injuries. Make sure to obey the followings:



CAUTION

- Beware of short circuits, as some circuits and vehicle components carry high current or voltage.
- If coolant overflows, wipe it with a dry cloth or tissue to prevent damage to components or vehicle paint.
- If brake fluid overflows, rinse it with water to prevent damage to components or vehicle paint.
- When replacing wiper blades, do not allow the wipers to scratch the glass surface.
- Before closing the hood, check whether any tool or wipe cloth is left in the engine compartment.
- When working inside or under the vehicle, always wear goggles to protect your eyes against flying or falling objects or splashing liquid.
- As brake fluid may damage the skin or eyes, be careful when filling it. If your skin or eyes are exposed to brake fluid, immediately flush with clean water. Seek medical attention immediately if discomfort persists.

Checks

The following items should be checked according to usage or specified mileage:

- Coolant level - Check the expansion tank coolant level at each charge.
- Windshield washer fluid - The residual amount of washer liquid in the tank should be checked monthly. When washer liquid is frequently used, the residual amount of liquid should be checked at each charge.
- Windshield wiper - Check wiper conditions monthly. If the wiper does not work, check it for wear, cracking, or other damage.
- Brake fluid level - Check the level monthly.
- Brake pedal - Check whether the brake pedal is operating properly.
- EPB switch - Check whether the switch is functional.
- Low-voltage battery - Check battery conditions and check for terminal corrosion monthly.
- A/C system - Check the operation of A/C units weekly.
- Tires - Check tire pressure monthly. Check tread wear and whether there are foreign bodies embedded.
- Windshield defrosters - Check the defroster vent monthly.
- Lights - Check the condition of headlights, position lights, tail lights, high mount brake light, turn signals, rear fog lights, brake lights and license plate light monthly.
- Doors - Check whether the trunk lid and all other doors (including rear doors) can be opened freely and locked securely.

- Horn - Check whether the horn is functioning properly.

REMINDER

- Do not continue driving a vehicle that has not been inspected, as this may result in serious vehicle damage and personal injury.

Combination Lights

Front combination lights

- Front combination lights are aligned before vehicle delivery. If the vehicle carries heavy load frequently, front combination lights may need to be realigned. It is recommended to have the front combination lights aligned by a BYD authorized dealer or service provider.

Fogging of lights

- Combination lights, tail lights, and turn signals on the side mirrors may become foggy after heavy rain or cleaning. This is similar to condensation on the side window during rain. It does not mean any problem with your vehicle.
- The lights are a relatively enclosed and narrow space. The temperature is very high when they light up (the mask and reflector could be burned and deformed easily), so they need heat dissipation. There are heat dissipation holes on the lamp housing for convection. The greater the temperature difference is, the more active the convection is. During the convection, the moisture in the air inevitably enters a lamp. Factors such as exposure to sunlight, convection, and bulb heating can cause the moisture in the air to condense into fog or water beads easily on the lamp surface at low temperatures. This is called fogging of lights.

REMINDER

- If fog presents inside the combination lights and inside the turn signal on the side mirror, it may be due to high air humidity or significant temperature difference between the vehicle and its surroundings. In that case, turn on the combination lights or turn signal while driving. The fog will evaporate after a short period of driving.
- If there is a noticeable amount of water inside the lights, it is recommended to drive the vehicle to a BYD authorized dealer or service provider for maintenance.

Sunroof Maintenance

Panoramic Sunroof Maintenance*

1. Wipe off dust or sand on the outer sealing strips of the sunroof with a damp cloth to avoid scratches, which may reduce sunroof sealing performance.
2. Wipe off dust or sand on the molding edges of the front glass with a damp cloth to avoid scratches, which may reduce sunroof sealing performance.
3. Clean the front of rear glass (with the front glass fully opened) frequently to avoid the accumulation of foreign materials like dust, sand, and leaves, and prevent such debris from blocking drainage holes, which could result in poor drainage of the sunroof.
4. Clean the rails on both sides and the front channels frequently to avoid the accumulation of foreign materials like dust, sand, and leaves, and prevent such debris from blocking drainage holes, which could result in poor drainage of the sunroof.

5. When washing the vehicle, do not aim high-pressure water jets directly at the sealing strips, to prevent high pressure from distorting even damaging the strips and water from leaking into the vehicle.
 6. The sunroof freezes easily in winter. Forcibly opening the frozen sunroof will damage sealing strips or other parts. Instead, warm up the vehicle and turn on the A/C system to accelerate the melting of snow and ice on the sunroof. Try to open the sunroof after the temperature inside reaches a certain level. Dry the residual moisture on the sunroof to prevent it from freezing.
 7. Do not open the sunroof fully on extremely bumpy roads. Vibration between the sunroof and the rail may deform related parts and even damage the motor. In addition, do not open the sunroof when it rains or the vehicle is being washed.
5. The sunroof freezes easily in winter. Forcibly opening the frozen sunroof will damage sealing strips or other parts. Instead, warm up the vehicle and turn on the A/C system to accelerate the melting of snow and ice on the sunroof. Try to open the sunroof after the temperature inside reaches a certain level. Dry the residual moisture on the sunroof to prevent it from freezing.
 6. Do not open the sunroof fully on extremely bumpy roads. Otherwise, the vibration between the sunroof and the rail may deform related parts and even damage the motor. And, do not open the sunroof when it rains or the vehicle is being washed.

Ordinary Sunroof Maintenance*

1. Wipe off dust or sand on the sealing strips of the sunroof with a wet cloth to avoid scratching them, which may affect their sealing performance.
 2. Wipe off dust or sand around the roof metal sheet with a wet cloth to prevent abrasion of sealing strips when the sunroof is closed, which may affect the sunroof sealing performance.
 3. Frequently clean the rails, front sash and other parts to avoid the accumulation of dust, sand, and leaves, and prevent the drainage holes from being blocked by such debris, resulting in water leakage into the vehicle.
 4. When washing the vehicle, do not aim high-pressure water jets directly at the sealing strips, to prevent high pressure from distorting even damaging the
- If the vehicle needs to be parked for a long time (more than a month), the following preparations should be made. Proper preparation helps prevent degradation and ensure easy use of the vehicle. If possible, park the vehicle indoors.
 - Charge the vehicle on time.
 - Thoroughly clean and dry the body surface.
 - Clean the interior of the vehicle to ensure that carpets and mats are completely dry.
 - Release the parking brake and set the gearshift lever in parking gear.
 - Open one window slightly (if the vehicle is stored indoors).
 - Disconnect the negative terminal of the low-voltage battery.

- Pad the front wiper arm with a folded towel or cloth to keep it out of contact with the windshield.
- To reduce adhesion, apply silicone lubricant to all door seals and body wax to the painted surface where the door seals meet.
- Cover the vehicle body with a breathable covering made of a "porous material", such as cotton. Non-porous materials, such as plastic sheeting, can build up moisture and damage the paint.
- If possible, start the vehicle regularly (preferably once every month). If the vehicle has been parked for a year or more, go to a BYD authorized dealer or service provider for comprehensive maintenance.

Hood

Opening the Hood

Open the hood

1. Do not open the hood when the wiper arms are pulled up, as this may damage the hood's Paint.
2. Pull the handle on the left under the dashboard twice in the direction of the arrow. The hood unlocks and opens slightly.



3. Lift up the hood and support it with a stay bar.

Close the hood

1. Remove the stay bar, put down the hood and confirm that it is connected in place.
2. Lower the hood slowly to about 30 centimeters above the front grille and release it, so that the fall locks it. Do not press the bonnet.



3. After closing the hood, check whether the latch is securely locked. If the hood can be lifted slightly, it indicates that it is not properly locked. Open the hood again and then close it correctly according to the above steps.

WARNING

- Do not press the front of the bonnet. Heavy pressure may damage the bonnet, causing dents in the surface or bending the edges.
- Do not force down the hood or release it from a high position.
- If the bonnet is not closed properly, it may suddenly open during driving, blocking the view to the front, resulting in accidents and injuries.
- After closing the hood, check whether the hood is level with the adjacent vehicle body, which means the hood is correctly close.

WARNING

- When closing the hood, confirm that nobody is within the range of the falling hood.
- If the hood is not closed tightly when driving, stop immediately and close the hood to prevent accidents!

Cooling System

- It is required that the liquid level should be between the Maximum(MAX) and Minimum(MIN) marker lines of the expansion tank.
- The coolant must always be of the same specification as the original, without adding any mixture. Different brands and types of coolant should not be mixed.

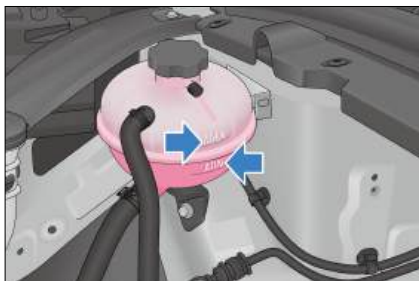

- Refill coolant to the MAX line if the level is below the MIN line. Check the cooling system for leakage.

REMINDER

- Do not add any rust inhibitor or other additives to the cooling system, for they may be incompatible with the coolant or the motor components.
- Before opening the reservoir cap, make sure that the motor,

REMINDER

high-voltage electronic control assembly, refrigerant reservoir and radiator are all cooled down. Opening the coolant expansion tank when the motor has not yet fully cooled down may cause coolant to squirt out, resulting in severe burns.

Braking System

- Check the level in the fluid tank monthly, and change the brake fluid according to the travel time and mileage specified in Maintenance Schedule.
- Be sure to use the brake fluid of the same specifications as the original brake fluid, and different types of brake fluid must not be mixed.
- It is required that the level in the fluid tank should be between "MAX" (maximum level) and "MIN" (minimum level) marks.
- If the level is below the MIN mark, check if the braking system leaks and the brake friction blocks are worn.

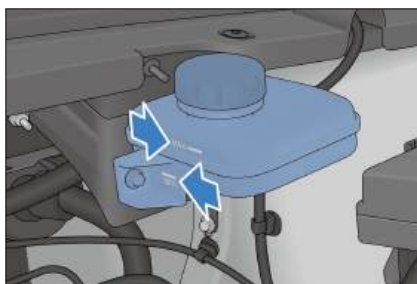

Washer

- During normal use, check the liquid level of the windshield washer reservoir at least monthly.
- If the windshield washer is used frequently, the level of the washer reservoir should be checked more frequently.
- High quality windshield washer fluid should be added to improve stain removal and prevent freezing in cold weather.

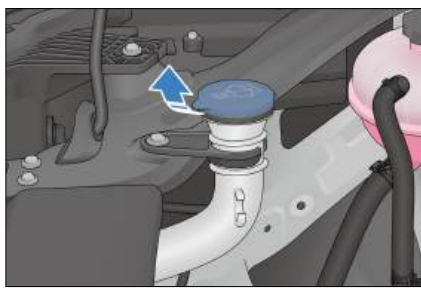

- When you add washer fluid to the fluid reservoir again, use a piece of clean cloth dipped with windshield washer fluid to clean the windshield wiper blade, which helps keep the blade edge in good condition.

CAUTION

- Do not inject vinegar-water solution or acid solution into the windshield washer fluid reservoir.
- It is recommended to use certified windscreen washing fluid having a pH value from 6.5 to 10.

A/C System

- The A/C system is a closed system, and any important maintenance work should be performed by professionals

from a BYD authorized dealer or service provider.

- The following practices help ensure that the A/C system works effectively.
 - Check the radiator and A/C condenser regularly.
 - Remove leaves, insects, and dust from the front surface of the A/C system. These deposits hinder the air flow and reduce the cooling effect.
 - In cold months, turn the A/C on once a week for at least 10 minutes to circulate the lubricating oil in the refrigerant unit.
- If A/C cooling efficiency decreases, go to a BYD authorized dealer or service provider for maintenance.

CAUTION

- Whenever the A/C system is maintained, the maintenance station should use a refrigerant recycling system. Such systems recycle refrigerant to avoid environmental pollution caused by directly discharging refrigerant.

Wiper Blades

The blade strip, made of synthetic rubber, is a vulnerable part. Various service environment of the vehicle and usage habits of drivers can damage the blades. Therefore, please observe the following to ensure the service life of blades and driving safety:

- Do not use a blade to remove ice from the windshield surface. Use a customized ice scraper.
- Do not scrape the windscreen surface if it is dirty, greasy or waxy.
- Keep the windshield surface clean. Do not scrape dust, sand, insects,

or foreign bodies on the windshield surface.

- During vehicle washing and body paint maintenance, there is no need to wax the windshield, as the wax layer reflects light in bad light, affecting the line of sight and driving safety. After washing the vehicle, rinse the blade with plain water, and use special windscreen wax cleaner to remove the wax layer on the windshield.
- To prevent excessive water pressure from damaging the blades, do not wash the blades directly with a water jet.

Maintenance Rules

- Clean windshield and blade regularly (preferably once a week or once every two weeks).
- Wipe the wiper regularly (preferably once a day or once every two days). When using a blade to wipe the windshield, keep the windshield fully wet. (When there is no rain, the washer liquid must be sprayed in advance).
- Clean the windshield with a special windshield washer fluid.
- Promptly clean mud and insect carcasses stuck to the windshield with a rag.
- When there are marks on the windshield caused by gravel, maintenance must be carried out timely. (It is recommended that windshield repair resin products should be used and the windshield should be replaced if marks are too large or too many.)
- Replace the wiper blades regularly, preferably once every six months.
- When cleaning the windshield, raise the wiper arm in advance. The specific operation method is as follows:

1. Go to  → **Service** → **Overhaul** to enable front wiper maintenance. The wipers rotate down.
2. Grasp the upper end of the wiper arm and carefully lift the wiper arm and blade assembly.

Tires

- For safe driving, tires must be made and sized to fit the vehicle, with good tread and standard tire pressure.

WARNING

- Using tires with excessive wear or insufficient/excessive pressure can result in accidents, severe injury, or death.
- Please follow all instructions in this manual regarding tire inflation and maintenance.

Tire Inflation

- Keep tires properly inflated to provide the best combination of maneuverability, tread life, and driving comfort.
- Under-inflated tires can cause uneven tire wear, affect maneuverability and energy consumption, and are prone to leakage due to overheating.
- Over-inflated tires reduce riding comfort and are prone to damage from uneven roads. In severe cases, the risk of tire bursting poses severe threats to the safety of the entire vehicle. Over-inflation will also cause uneven wear and tear of tires, affecting tire service life.
- When tires are cold, you can decide whether to replenish tire pressure according to the tire pressure values displayed on the instrument cluster.

- Tire pressure should be measured while tires are at ambient temperatures. This means that it should be measured at least three hours after stopping the vehicle. If you must drive the vehicle before the tire pressure is measured, tires can still be considered at ambient temperatures as long as the traveled distance is not more than 1.6 km.
- It is normal that tire pressure reading measured while tires are hot (after travel of several kilometers) is 30-40 kPa (0.3~0.4 bar) higher than when tires are cold. In that case, do not deflate tires in order to achieve the specified cold tire pressure reading; otherwise, the tire pressure will be insufficient.

! REMINDER

- The recommended cold tire pressure is indicated on the label affixed to the driver's door frame.
- Tubeless tires have a self-sealing function when they are punctured. However, because in fact usually there is a very slow air leak, as soon as the tire begins to depressurize, carefully look for the leak location.

Tire Checks

- Whenever checking tire inflation, check tires for damage, foreign body piercing and wear.
 - Replace the tire if bumps, or tread or side damage are found. Tires should be replaced if any of the cases happens.
 - Replace the tire if there are cracks on its side or if its fabric or cord can be seen.

- Replace tires with excessive tread wear.
- Tire treads are cast with wear bars. When the tread is even with the wear bar, its thickness is less than 1.6 mm. The adhesion of tires worn to this extent is very small on wet roads.



- Tires with exposed wear bars are experiencing serious performance loss and therefore must be replaced.

Replacing Tires and Wheels

- Original tires maximize performance, while providing the best combination of maneuverability, driving comfort and service life.
- It is recommended to replace with original tires at a BYD authorized dealer or service provider.
- Replacement of tires with different sizes, road ranges, rated speeds and maximum cold pressures (marked on the tire side) or mixed use of radial tires and diagonal tires can reduce braking ability, driving force (ground adhesion) and steering accuracy.
- Unsuitable tires affect the maneuverability and stability of the vehicle, and may lead to accidents.
- Do not replace only one tire; otherwise it will severely affect the maneuverability of the vehicle.

- ABS works by comparing wheel speed. When replacing a tire, use a tire of the same size as the original tire. The size and structure of the tire affect wheel speed and may lead to uncoordinated system operation.
- If the wheel needs to be replaced, ensure that the specifications of the new wheel match those of the original wheel. New wheels are available for purchase at BYD authorized dealer or service providers. Please consult a BYD authorized dealer or service provider before replacing the wheels.

WARNING

- Please observe the following precautions to ensure proper vehicle maneuverability and control.
 - Do not mix radial tires, bias belted tires, or diagonal ply tires on the vehicle.
 - Do not use tires with dimensions other than those recommended by the manufacturer.

Tire Rotation

- In order to make tires wear the same and prolong their service life, it is recommended to check the wear of the tire inner and outer tread every 10,000 km and conduct four-wheel alignment, inspection and adjustment as well. Rotate the tires if necessary.
- Do not rotate tires when a spare tire is used for the vehicle.
- When purchasing replacement tires, you may find that some tires are "directional", which can only be rotated in one direction. If directional tires are used, only the front and rear wheels can be swapped in tire rotation.

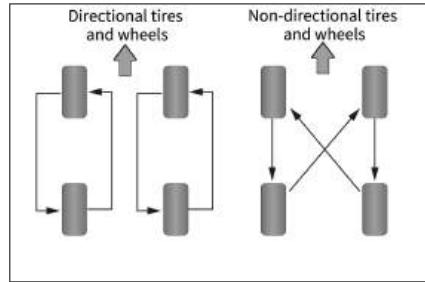

- After tire replacement, contact a BYD authorized dealer or service provider for tire pressure matching.

Maintenance

- In addition to proper inflation, proper wheel alignment also helps reduce tread wear.
- If uneven tire wear is found, go to a BYD authorized dealer or service provider and check the wheel alignment.
- Although the vehicle has been balanced in the factory, it needs to be re-balanced after running for a period of time.
- If there is some kind of continuous vibration while driving at high speeds (above 80 km/h), but not at low speeds, go to a BYD authorized dealer or service provider and check the tires.
- If a tire has been repaired, be sure to re-balance it.
- After installing a new tire or replacing a new wheel, always perform tire balancing.

CAUTION

- Improper placement of wheel balance blocks will not stick firmly and fall off, which will damage your vehicle or surrounding things while driving.

CAUTION

- Improper placement of wheel balance blocks will damage the aluminum alloy rims of your vehicle. Therefore, it is recommended to use original wheel balancers to keep balance.

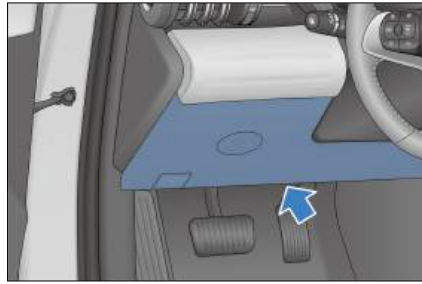

Fuses

All vehicle circuits are provided with fuses to prevent short circuit or overloading. These fuses are mounted in the under-hood and dashboard PDBs, respectively. Fuse labels are included in these PDBs, showing the correspondence of fuses with electrical components.

- The fuses under the hood are located at the left rear part in the engine compartment. To open the PDB, remove the trim first, and press the latch as shown.

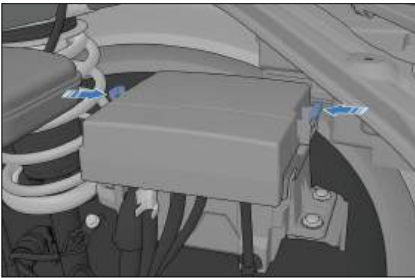

- The dashboard fuse under the driver's side is located on the left side of the dashboard. Take apart the lower body of the dashboard to check the fuse.
- Replacement of blown fuses with ones of higher amperage can significantly increase the likelihood of damage to the electrical system.
- If there is no spare fuse of the same amperage, use a fuse with lower amperage instead.

REMINDER

- Do not use fuses with amperage higher than the rated ampere value or any other solution to replace the fuses, as this can cause serious damage or even a fire.
- If a fuse blows, it is recommended to check or replace the fuse at a BYD authorized dealer or service provider.

07

WHEN FAULTS OCCUR

When Faults Occur.....186

When Faults Occur

If Smart Key Battery Is Exhausted

If the smart key indicator does not flash and the vehicle cannot be started using the start function, the smart key battery may be exhausted. It is recommended to contact a BYD authorized dealer or service provider for battery change as soon as possible. In this case, you may start the vehicle in no power mode.

CAUTION

- Do not place the smart key in a position exposed to high temperature.
- Do not hit or slam the key with hard objects.
- Check for nearby radio stations, substations or airport radio transmitters that may interfere with the normal operation of electronic smart keys.
- After locking the vehicle and arming its anti-theft alarm system, keep the key away from the vehicle; otherwise the automatic card finding of the vehicle will consume the power of the low-voltage battery and the smart key.

1. Use the mechanical key to unlock the vehicle.
2. Hold the smart key close to the no-power sign on the auxiliary dashboard.
3. Press the START/STOP button while pressing the brake pedal.

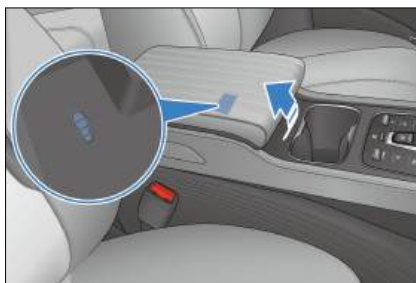

Emergency Shutdown System

- The emergency shutdown system is activated and the high-voltage system is automatically shut down when the following conditions are met:
 - The airbags do not deploy after a frontal collision.
 - There is a rear collision.
 - The vehicle system is faulty.
- The OK indicator goes off if any of the above situations occurs.
- Activating the emergency shutdown system in the noted types of collision minimizes the risk of injuries or accidents.
- The vehicle system cannot be switched into the OK status once the emergency shutdown system is activated. In that case, it is recommended to contact a BYD authorized dealer or service provider for help. The system is turned off immediately even if the ignition is switched on. Contact a BYD authorized dealer or service provider as soon as possible.

Vehicle Fire Rescue

In case of fire, continue to operate the vehicle as follows according to the actual situation:

1. Switch the ignition off, and leave the vehicle.
2. On the precondition that personal safety is ensured, if the fire is small and slow, use a dry powder fire extinguisher to put out the fire, and call for help immediately.
3. If the fire is large and growing quickly, stay away from the vehicle and call the fire brigade, informing them that the vehicle is equipped with a high-voltage battery pack, and wait for rescue.



CAUTION

- Wear insulated gloves during vehicle disassembly. Use fire extinguishers of designated type. Water or incorrect fire extinguishers may cause electric shock.
- In the event of other special conditions that cause flying projectiles (such as interior trims and glass), stay away from the vehicle and promptly ask a BYD authorized dealer or service provider to come to the site for handling.

Battery Leakage Rescue

After a collision, if there is battery leakage, an acrid smell inside the vehicle, visible acid flow outside the vehicle, or any smoke with the battery pack:

1. Switch the ignition off, and disconnect the low-voltage battery if conditions permit.

2. Call a BYD authorized dealer or service provider and the fire brigade, informing them that the vehicle is equipped with a high-voltage battery pack, and wait for rescue.

If a Collision Occurs

In case of collision, operate the vehicle as follows according to the actual situation:

1. Switch the ignition off, and disconnect the low-voltage battery if conditions permit.
2. Call immediately a BYD authorized dealer or service provider for rescue.
3. Carry out a simple inspection, if conditions permit: Check whether any edge of the high-voltage battery tray is cracked and whether any obvious liquid flows out.

- Damage to high-voltage components is not identifiable in all cases. Do not handle damaged components or touch them with jewelry or other metal objects.
- If skin comes in contact with leaked fluid, wash it immediately with plenty of water for 10-15 minutes. If there is still any discomfort, apply 2.5% calcium gluconate ointment, or soak in 2% to 2.5% calcium gluconate solution for 10-15 minutes. If the condition does not get better or discomfort persists, seek medical help immediately.

- Do not touch the orange high-voltage cables or other high-voltage components. Only authorized repair personnel is allowed to work on high-voltage systems.
- Do not damage, modify, disassemble, or disconnect the orange high-voltage cables from the high-voltage grid.

- Inform the firemen and rescue personnel that the vehicle is equipped with a high-voltage battery pack.

WARNING

- Do not touch any spilled liquid, and stay away from a leaking vehicle or high-voltage battery.
- Do not dispose of the leaked fluid into the water or soil or other environment.
- In case of vehicle breakdown or collision, the high-voltage system generates a lot of heat before and after vehicle start-up and when the vehicle is powered off. Watch out for high pressures and high temperatures.
- Do not disassemble, move, or alter high-voltage battery components and connecting cables as their connectors can cause serious burns or electric shock and may result in personal injury or death. The orange cables are part of high-voltage wiring harness. Users must not repair the vehicle's high-voltage system by themselves. If any repair is required, it is recommended to go to a BYD authorized dealer or service provider for repair.
- The remote control key and high-voltage components of the vehicle may affect and harm people carrying medical devices.

If the Vehicle Needs Towing

If the vehicle needs towing, it is recommended to contact a BYD authorized dealer or service provider, a professional towing service, or the

organization you joined for roadside assistance.

WARNING

- The vehicle must not be towed by other vehicles using only ropes or chains.

Recommended towing methods:

- Flatbed device
 - If the vehicle fails and needs towing, a flatbed is recommended. When the vehicle is being towed, keep its four wheels off the ground. Towing the vehicle on front or rear wheels alone may damage high-voltage components.



CAUTION

- When moving a vehicle on a flat trailer, make sure that the vehicle being moved is properly secured to prevent it from sliding back.
- It is recommended to use professional tire straps and tighteners, and over-the-wheel lashing is recommended for securing moved vehicles.
- When fixing the vehicle, do not pass the fixtures such as straps and ropes through the wheels or tie them on the chassis,



CAUTION

suspension and other body parts to prevent damaging the vehicle.

- When transporting a vehicle, make sure that the wheels of the moved vehicle cannot turn to avoid damage to the vehicle.

Tow Eye

The installation point of vehicle tow eye is shown in the illustration.

1. Pry it open with a cross screwdriver.
2. Install the tow eye in the tow eye opening.

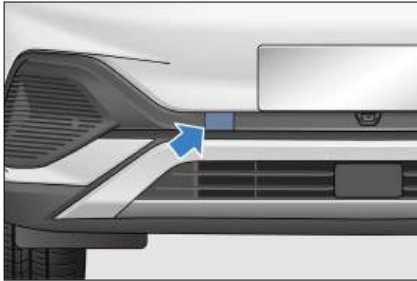

- If the vehicle needs rescue, it is recommended to call a professional rescue or the customer service number.
- In emergency rescue situations where the vehicle needs to be towed, observe the following to avoid vehicle damage or personal injuries:
 - The towing vehicle must be in good conditions and the towed vehicle in Neutral; the tow speed must be no more than 5km/h.
 - Never use jerking actions to pull the vehicle.
 - The towed vehicle must not carry any person except for the driver.

- Both towing and towed vehicles must have their hazard warning lights on.
- Only the in-vehicle tow eye can be used, to avoid damages to the vehicle.
- The distance between the towing and towed vehicles must be more than 4 meters but less than 10 meters.
- The width and weight of the towed vehicle must not be greater than those of the towing vehicle.
- When towing the vehicle, ensure its surroundings are unobstructed and have enough space and no person is close to the towing device.
- When freeing the vehicle, control to make it travel in the direction of tow force. Dragging the vehicle from the side or vertically is prohibited.
- The towed vehicle must be controlled by a driver inside the cabin, with the steering and braking systems in normal conditions.



WARNING

- Rescuing a stuck or high-centered vehicle by using the tow eye is prohibited. Instead, calling a professional rescue or the customer service number is recommended.
- If the steering or braking system of the towed vehicle fails, contact a professional rescue or the customer service number. Do not tow the vehicle in such cases.

If a Tire Goes Flat

- In case of a flat tire, slow down, keep straight and drive off the busy road to a safe place.

- Park on solid, flat ground and avoid motorway forks.
- Engage the EPB and press the "P" button.
- Power off the vehicle and turn on the hazard warning light.



- Be sure to have all passengers get off the vehicle and ask them to go to a safe place away from crowded traffic.
- To prevent slipping, secure the vehicle by wedging the tire diagonally against the flat tire.

⚠ CAUTION

- Do not continue driving with a flat tire. Even a short distance of driving with flat tire can cause irreparable damage.

In-Vehicle Tools

In-vehicle tools are stored in a tool box under the trunk cover flap.

These include: warning triangle, reflective vest, lug nut cap removal clamp, tire repair kit, and tow eye.

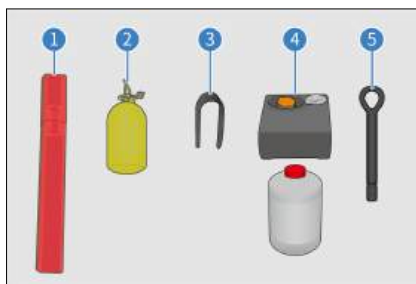

- The reflective vest is in the glove box or in the tool kit.
- In case of a sudden breakdown during driving, if you need to get out of the vehicle urgently to check for faults or handle accidents, always wear the reflective vest properly before that to ensure your safety.

Placing the warning triangle

ⓘ REMINDER

- When parking for repair, remember to place the red triangle side facing oncoming vehicles, 100-200 meters away from the vehicle. After the repair, recover the warning triangle for future use.

The warning triangle is used to warn vehicles coming from behind and to avoid collisions due to high speed or late braking.

How to use the warning triangle:

1. Take the warning triangle out of its box.
2. Attach the ends to form a triangle.
3. Release its supports to create a pattern as shown.



Using Tire Repair Kit*

- The tire sealant is used to seal small cuts, especially cuts in tread pattern. It is just an emergency solution for you to drive to the nearest service center, and only for short emergency stretches, even if the tire is not deflated.

WARNING

- At most, the tire repair kit can repair holes that are on the tire tread and are within 6 mm in diameter. Do not use the kit on holes with larger diameters or in other tire positions, but call for roadside assistance instead.
- Tire sealant is highly flammable and harmful to health. Take necessary precautions to prevent fire and avoid contact with skin, eyes, and clothing; keep away from children; and do not inhale its vapor.

In case of contact with tire sealant:

- If tire sealant comes into contact with the skin or gets into the eyes, thoroughly flush the affected body part immediately with plenty of clean water.
- Change contaminated clothing immediately.

WARNING

- In case of an allergic reaction, seek medical attention immediately.
- If tire sealant is ingested by accident, rinse mouth thoroughly and drink plenty of water immediately. Do not induce vomiting, but seek medical attention immediately.

Using the tire repair kit

- See labels on the inflator and tire sealant for usage of the kit.
- If the inflator needs to be connected to a power source, plug the inflator into the vehicle's 12V socket, start the vehicle, and turn on the inflator. The tire sealant is then filled through the inflator hose into the tire along with air.

REMINDER

- Make sure the inflator switch is off when you plugging the power supply into the 12V socket in the vehicle.
- The inflator can only be turned on for up to 10 minutes.
- Observe the tire pressure reading on the inflator.
 - If the tire pressure does not reach 180 kPa (1.8 bar) within 10 minutes (red area shown in the figure), turn off the inflator. You are recommended to contact a BYD authorized dealer or service provider.

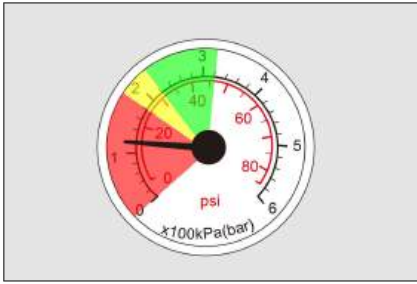

- If the tire pressure reaches between 180 and 320 kPa (1.8~3.2 bar) (green and yellow areas shown in the figure), remove the kit as soon as possible and drive at a speed below 80 km/h within one minute, with the furthest driving distance not exceeding 10 km, so that the tire sealant is evenly distributed within the tire.

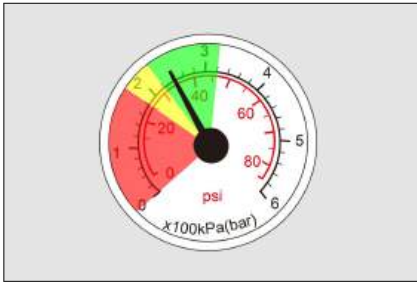

- Stop to check the repaired tire and the tire pressure gauge reading on the inflator.
- If the tire pressure is greater than 220 kPa (2.2 bar), drive to the nearest service center at a speed below 80 km/h.
- If the tire pressure is between 130 and 220 kPa (1.3~2.2 bar), repeat the process to fill the tire sealant into the tire and observe the tire pressure gauge reading on the inflator.
- If the tire pressure does not reach 130 kPa (1.3 bar), it is recommended to contact a BYD authorized dealer or service provider.

! REMINDER

- Using tire sealant on damaged tires is only an emergency solution. Please change the tires at a professional repair center as soon as possible. It is recommended that you contact a BYD authorized dealer or service provider and inform the maintenance technician that tire sealant has been used.
- Avoid hard acceleration and high-speed turns.
- Abide by the maximum vehicle speed limit of 80 km/h. Do not continue driving if any strong vibration, driving instability, or noise occurs while the vehicle is running.
- When the tire sealant is about to expire (see the label on the canister for exact date), replace it with a new one.
- After using the tire repair kit, it is recommended to purchase new tire sealant at a BYD authorized dealer or service provider.

08

SPECIFICATIONS

Data.....	194
Information.....	198
Declarations of Conformity.....	200

Data

Vehicle Data

Dimensions:

Item	Parameter
Length (mm)	4455
Width (mm, excluding side mirrors)	1875
Height (mm)	1615
Wheelbase (mm)	2720
Front track (mm)	1575
Rear track (mm)	1580
Front overhang (mm)	888
Rear overhang (mm)	847
Approach angle (°)	19
Departure angle (°)	24

Vehicle mass:

Item	Parameter
Curb weight (kg)	1750
Maximum allowable total mass (kg)	2160
Front axle load at maximum allowable total mass (kg)	1070
Rear axle load at maximum allowable total mass (kg)	1110
Number of occupants (persons)	5

Drive motor:

Item	Parameter
Drive motor model	TZ200XSQ
Type	Permanent magnet synchronous motor
Drive type	Front-wheel drive

Item	Parameter
Rated power/speed/torque (kW/rpm/Nm)	65/4433/140
Peak power/revolving speed/torque (kW/rpm/N · m)	150/4620/310

Vehicle power performance and economic efficiency:

Item	Parameter
Maximum speed (km/h)	160
Maximum gradeability (%)	30
Power consumption per 100 km under comprehensive working conditions (kWh/100 km)	≤16



CAUTION

- Actual power consumption depends on factors such as vehicle conditions, road conditions and driving habits.

Wheels and tires:

Item	Parameter
Tire specification	235/50 R18; 215/55 R18
Tire pressure (kPa)	250
Wheel dynamic balance requirement (g)	≤10

Wheel alignment values (at curb weight):

Item	Parameter
Front camber (°)	-0.9±0.75
Total front wheel toe-in (°)	0.116±0.16
Kingpin inclination angle (°)	11.47±0.75
Kingpin caster angle (°)	3.23±0.75
Rear wheel camber (°)	-1.07±0.5

Item	Parameter
Total rear wheel toe-in (°)	0.17±0.2

Braking system:

Item	Parameter
Free stroke of brake pedal (mm)	1-5
Front brake disc standard thickness (mm)	26
Front brake disc minimum thickness (mm)	24
Rear brake disc standard thickness (mm)	12
Rear brake disc minimum thickness (mm)	10
Front friction plate standard thickness (mm)	8
Front friction plate minimum thickness (mm)	2
Rear friction plate standard thickness (mm)	6.5
Rear friction plate minimum thickness (mm)	2

High-voltage battery:

Item	Parameter
Type	Lithium iron phosphate battery
High-voltage battery rated capacity (Ah)	150

Recommended oil type and amount:

Item	Parameter
Gear transmission oil type	Castrol BOT384 (recommended), Castrol BOT383, Castrol W5
Transmission gear oil amount (mL)	600±50
Motor coolant type	Glycol organic acid coolant -40 °C
Motor coolant amount (L)	3.5±0.5
Brake fluid type	DOT4 or HZY6
Brake fluid amount (mL)	1050±50



CAUTION

- The recommended oil types have been tested and approved by BYD. Using other types may result in vehicle performance degradation, and even malfunction or component damage.

Seats (when measuring cushion depth):

Item	Parameter
Seatback angle set for front seats	23°
Forward and backward moving spaces for front seats	200 mm forward and 60 mm backward from designed position; slide rail inclination: 4.5°
Normal service conditions of front seatbacks	Seatback 22.5° forward and 52.5° backward from the designed position
Seatback angle set for rear seats	27°
Forward and backward moving spaces for rear seats	Design condition, not adjustable (lay down when unlocked)
Normal service conditions of seatbacks	27°

Vehicle Identification

Vehicle Identification Number (VIN)

- ① Attached on the gearbox
- ② Attached on the sheet metal surface inside the hood
- ③ Attached on the lower right side of the trunk sheet metal
- ④ Attached on the VIN slot on the upper cover of the left front windshield cross sill
- ⑤ Attached on the sheet metal clad of the right rear wheel envelope.
- ⑥ Attached on the sheet metal surface inside the left rear door sill
- ⑦ Attached on the sheet metal surface at the lower left corner of the front left door

- ⑧ Attached on the sheet metal surface of the front bumper beam



VIN is engraved on the lower beam of the front passenger seat as shown. After connecting the VDS, Vehicle Identification Number(VIN) can be found in the upper right corner of the screen for the corresponding model. For details, please refer to the VDS operation manual.

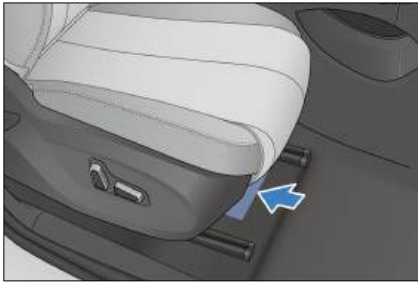

Vehicle Nameplate

The vehicle nameplate is located under the right B-pillar.

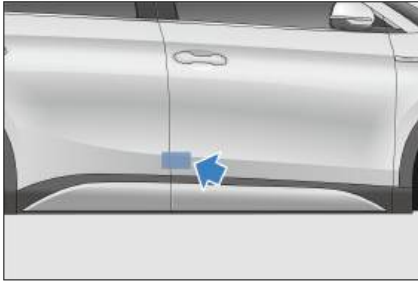

Model and Serial Number of Drive Motor

- ① Attached near the lock ring right under the hood.
- ② Engraved on the underside of motor housing.

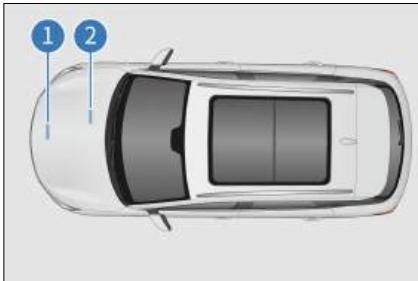

Information

Warning Labels

- ① A/C system and cooling fan label
- ② Battery position label



Side airbag warning labels are attached below the left and right B-pillar lock rings.



Airbag warning labels are printed on the front and back of the right sun visor.

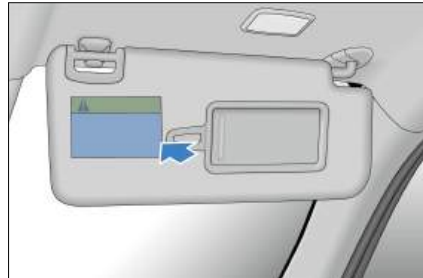

WARNING

- Never use a rearward facing child restraint on a seat protected by an active airbag in front of it. Death or serious injury to the child can occur.

The tire pressure label is attached below the left B-pillar lock ring.



The child protection lock label is engraved on the metal sheet surface on the left/right rear door.



The charging connector use tip label is attached to the inner surface of the charge port door.

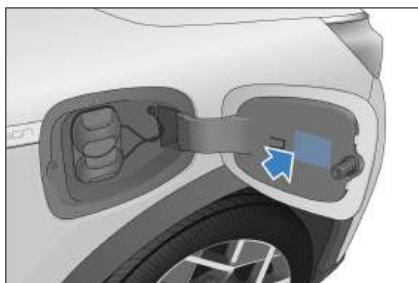

High-voltage label attaching position:

- ① On the upper safety cover of powertrain power controller, and small cover of drive motor rear bracket
- ② On the AC charging cable in the engine compartment
- ③ On the distribution wire
- ④ On top of the front seal cap of battery pack

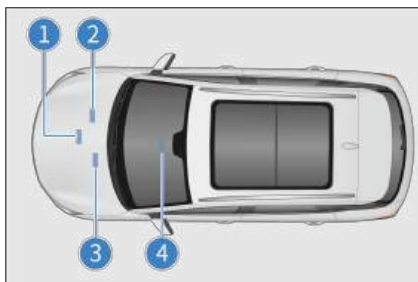

Transponder Mounting Position

The transponder mounting position is located in the upper right of the front windshield.

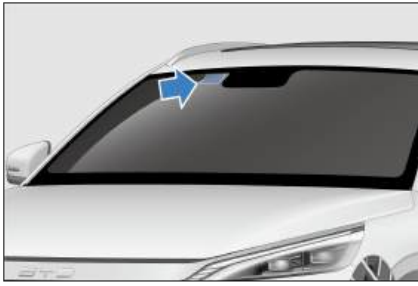

⚠ CAUTION

- Do not overlap the sticker transponder with the glass frame or other objects.

Declarations of Conformity

Radio Frequency



Your vehicle has different types of radio equipment. The manufacturers of the radio equipment declare that the RF Modules are in compliance with Directive 2014/53/EU. The full text of the EU declaration of conformity is available at the following Internet address: <https://cn-prod.byd.com/eu/eu-doc>.

Component Name	Frequency	Maximum Power
Tire pressure monitoring transmitter module	434 MHz	87 dBμV/m ± 2 dB
Interior detection antenna	125 KHZ	10 W
Electronic smart key	434 MHz	10 dbm
High-frequency reception module	434 MHz	0.48 W
ECALL GPS antenna	1559 MHz – 1605 MHz	0.05 W
ECALL 4G antenna	701 MHz – 960 MHz	0.05 W
	1.71 GHz – 2.69 GHz	0.05 W
NFC device	13.56 MHz	1W
On-board Bluetooth device	2.402 GHz – 2.480 GHz	8 dBm
Wi-Fi hotspot device	2.402 GHz – 2.482 GHz	16 dBm

Component Name	Frequency	Maximum Power
	5.17 GHz – 5.835 GHz	
Network communication four-in-one antenna (4G)	701 MHz – 960 MHz	/
	1.71 GHz – 2.69 GHz	/
Network communication device (4G)	700 MHz – 2600 MHz	23 dBm
FM broadcasting antenna amplifier	76 MHz – 108 MHz	0.24 W
FM broadcasting device	76 MHz – 108 MHz	0.8 W
DAB antenna amplifier	170 MHz – 240 MHz	0.24 W
DAB box	170 MHz – 240 MHz	1.5 W
Four-in-one antenna (GPS, 4G, WiFi/BT)	1559 MHz – 1605 MHz (GPS Antenna)	0.03 W
	701 MHz – 960 MHz & 1.71 GHz – 2.69 GHz (4G Antenna)	
	2.4 GHz – 2.5 GHz (Wi-Fi/BT Antenna)	
MmWave radars	76 – 77 GHz	3W
AM antenna amplifier	522 KHz – 1800 KHz	0.6 W
AM device	522 KHz – 1800 KHz	0.8 W

Smart Key



Uzbekistan

Model: D0-92/D1-92



EU countries

Model: D0-92/D1-92



Brazil

Model: D0-92/D1-92

This equipment is not entitled to protection against harmful interference and may not cause interference to duly authorized systems.



Japan

Model: D0-315/D1-315

Numerics

12V Auxiliary Power..... 163

A

A/C Panel Buttons..... 154

A/C Settings Interface..... 154

A/C System Maintenance..... 180

Acoustic Vehicle Alerting System
(AVAS)..... 130

Adaptive Cruise Control (ACC)* 115

Adjusting Rear Seat Head Supports
..... 61

Adjusting the Steering Wheel
Manually..... 65

Air Purification System* 159

Airbag Overview..... 15

Anti-theft Alarm System..... 29

Automatic Vehicle Hold (AVH)..... 113

Automatic Vehicle Washing..... 173

B

Battery Leakage Rescue..... 187

Blind Spot Assist (BSA)* 125

Brake Fluid..... 179

Break-in Period..... 100

C

Cargo Cover..... 165

Carrying Luggage..... 103

Center Console Cubby..... 161

Charging Port Immobilizer System*
..... 93

Charging Safety Warnings..... 82

Check before Charging..... 86

Child Protection Lock..... 58

Child Restraint System..... 23

Coolant..... 179

Cup Holder..... 161

D

Data Collection and Processing..... 29

Discharging Device* 91

Door Bins..... 161

Driver Assistance Switches..... 73

Driver's Door Switches..... 71

Driving Precautions..... 114

Driving Safety Precautions..... 101

Driving Safety Systems..... 135

E

Electronic Smart Key..... 48

Emergency Shutdown System..... 186

Emergency Vehicle Locking with
Mechanical Key..... 54

EPB Switch..... 110

F

Fire Prevention..... 105

Front Interior Lights..... 78

Front Windshield Wipers and Washer
..... 68, 141

Function Definition..... 156

Fuses..... 184

G

Gear Shift Controls..... 109

Gestures and Responses..... 149

Glove Box..... 161

Grab Handles..... 162

H

Hazard Warning Light Switch..... 74

High-Voltage Battery..... 95

I

If a Tire Goes Flat.....	189
If Smart Key Battery Is Exhausted	186
If the Vehicle Needs Towing.....	188
Indicators and Warning Lights.....	37
Infotainment Touchscreen.....	148
Installing Child Restraint Systems.	24
Intelligent Cruise Control (ICC)* ...	119
Interior Cleaning.....	174

L

Lane Support System (LSS)*	124
LCD Instrument Cluster.....	36
Light Switches.....	65
Locking/Unlocking with Mechanical Key.....	50
Low-Voltage Battery.....	98

M

Maintenance Plan.....	168
Maintenance Schedule Requirements	168
Maintenance System*	170
Manual Vehicle Washing.....	172
Mode Switches.....	74

O

Odometer Switch.....	73
Opening the Hood.....	178
Ordinary Sunroof Maintenance*..	177

P

Paint Maintenance Tips.....	171
Panoramic View System*	130
Parking Assist System*	132
Predictive Emergency Braking (PEB)*	120

R

Regular Maintenance.....	170
Releasing EPB Manually.....	111

S

Saving Energy and Extending Vehicle Service Life.....	102
Scheduled Charging.....	90
Seat Belt Overview.....	12
Seatback Pockets.....	161
Seats.....	60
Self-Maintenance.....	174
Side Mirror Adjustment.....	140
Smart Access and Start System.....	57
Snow Chains.....	107
Starting the Vehicle.....	107
Steering Assist Mode Settings.....	65
Steering Wheel Switches.....	62
Suggestions for Vehicle Use.....	101
Sun Visor.....	162
Sunroof Maintenance.....	176
Sunroof Switch.....	77
Switching on A/C with Cloud Service App.....	160

T

Tire Pressure Monitoring.....	128
Tires.....	181
Traffic Sign Recognition (TSR)* ...	123
Trailer Towing.....	100
Transponder Mounting.....	199

U

USB Ports.....	163
Using Seat Belts.....	12

V

Vehicle Cleaning.....	172
-----------------------	-----

Vehicle Corrosion Prevention.....	170
Vehicle Data.....	194
Vehicle Fire Rescue.....	187
Vehicle Identification.....	197
Vehicle Storage Precautions.....	177
Vents.....	158

W

Wading into Water.....	104
Warning Labels.....	198
Washer.....	180
Window Control Switch on Passenger Side.....	74
Wiper Blades.....	180
Wireless Phone Charger*	163

Abbreviations

Terminology	Name	Terminology	Name
MCB	Multi-Collision Brake	ECU	Electronic Control Unit
ISOFIX	International Standards Organization Fix	EDR	Event Data Recorder
ABS	Antilock Braking System	AUTO	Automation
ACC	Adaptive Cruise Control	ECO	Ecology, Conservation, Optimization
NORMAL	Normal	SPORT	Sport
SOC	State of Charge	E-Call	Emergency Call
VTOL	Vehicle to Load	EPB	Electronic Parking Brake
ICC	Intelligent Cruise Control	LKS	Lane Keeping System
PCW	Pedestrian Collision Warning	AEB	Automatic Emergency Braking
TSR	Traffic Sign Recognition	BSA	Blind Spot Assist
DOW	Door Open Warning	RCW	Rear Collision Warning
RCTA	Rear Collision Traffic Alert	RCTB	Rear Cross Traffic Braking
TPMS	Tire Pressure Monitor System	AVAS	Acoustic Vehicle Alerting System
AVH	Auto Vehicle Hold	ESC	Electronic Stability Controller
VDC	Vehicle Dynamics Control	TCS	Traction Control System
HHC	Hill Hold Control	HBA	Hydraulic Brake Assit
CDP	Controller Deceleration Parking	HDC	Hill Descent Control
PM2.5	Particulate Matter 2.5	USB	Universal Serial Bus
MAX	Maximum	MIN	Minimum
VIN	Vehicle Identification Number		

BUILD YOUR DREAMS

Edition date: 09.2024 EN_V4 Left-hand Drive